

2024

OFF ROAD
ON ROAD
BIKE



CIRCUIT
EQUIPMENT

FROM **1984**

CIRCUIT EQUIPMENT was founded in 1984 by the dynamic owner Renato Breda. Participating in Motocross tracks as a rider led him to learn and study the needs in a constantly evolving environment and, from there, in a few years, his company became a reference in the South American market. Following development, the company has consolidated its operations in Italy, the USA and the Middle East in addition to a presence in more than 40 countries with exclusive distributors. Today the Circuit brand is present on all continents and has a strong presence with riders and teams in the most important Motocross, Supermoto and Enduro world championships, in addition to offering a wide range of products for on-road motorcycles and bikes!



BRAZIL

ITALY

U.S.A.

UAE

ARGENTINA

AUSTRALIA

AUSTRIA

BELGIUM

BOLIVIA

BULGARIA

CHILE

COLOMBIA

COSTA RICA

CYPRUS

CZECH REPUBLIC

ECUADOR

FINLAND

FRANCE

GERMANY

GREECE

GUATEMALA

HUNGARY

ICELAND

IRELAND

ISRAEL

LATVIA

LUXEMBOURG

MEXICO

NETHERLANDS

NEW ZEALAND

NORWAY

PARAGUAY

PERU

POLAND

PORTUGAL

REUNION

ROMANIA

SLOVENIA

SPAIN

SWEDEN

SWITZERLAND

TAIWAN

THAILAND

UNITED

KINGDOM

URUGUAY



SAO PAULO BRASIL

FL. U.S.A.

IN THE WORLD

DISTRIBUTOR IN OVER 50 COUNTRIES

WWW.CIRCUIT84.COM

BERGAMO ITALY

 DUBAI UAE

INDEX

08

FEATURES

16

HANDGUARDS

26

GRIPS

35

DISC COVER

37

FENDERS

41

HEADLIGHTS

42

TAILLIGHTS

43

NUMBER PLATES

46

THROTTLES

47

HANDLEBARS

49

BAR PADS

51

FORK BOOTS

54

KIT CRF

55

GEAR OFF ROAD

60

CHEST PROTECTORS

62

GOGGLES

64

SPARE PARTS

66

ACCESSORIES

70

ON ROAD INDEX

123

BIKE

136

CASUAL LINE



CIRCUIT2024

GEAR

JERSEY

Entirely made with materials of very high quality. Made from 100% breathable polyester and of high tenacity. S - M - L - XL - XXL

PANTS

Condura dupont, material certified to have abrasion resistance and 30% with nylon top quality. 100% lining made in nylon. It has a system of rubber adjustment natural and certified according to the rith rules. Fabric printed by sublimation with non-ecological inks polluting and non-toxic. 36 - 38 - 40 - 42 - 44 - 46 - 48





JERSEY
TS157-264 YE
PANTS
TS156-264 YE

JERSEY
TS157-216 BK
PANTS
TS156-216 BK

GEAR 2024



JERSEY
TS157-249 BL
PANTS
TS156-249 BL



JERSEY
TS157-256 RD
PANTS
TS156-256 RD

2024 GLOVES

Developed especially for meet the requirements of the best motorcycle riders. Internally seamless and padded in the palmar area, prevents the blistering on hands and provides the best grip. It has silicone inserts on the index finger posts and averages to improve performance using the brake lever. It has rubber protection on the top of the ring fingers and medium to ensure more security to the pilot's hand and prevent them from hurt whenever the levers are pulled with greater force. fingers indicators made with special fabric to facilitate, if necessary, cleaning of the glasses when dirty.

FIST

HAND  WEAR

2024 GLOVES



SIZES
TS155-215-S BK/RD
TS155-215-M BK/RD
TS155-215-L BK/RD



T-REX PROTECTOR

Able to use of the vest over or under the uniform with more convenience, comfort and practicality.

The Circuit T-REX UNDER Motocross Vest provides the use of a hydration bag or backpack. Greater mobility and breathability for riders, with perfect adjustments, the Vest Motocross Circuit T-REX UNDER

It has elastic straps on the sides, adjustable straps in addition to several air intakes providing better comfort.

Heat, even using thicker shirts.

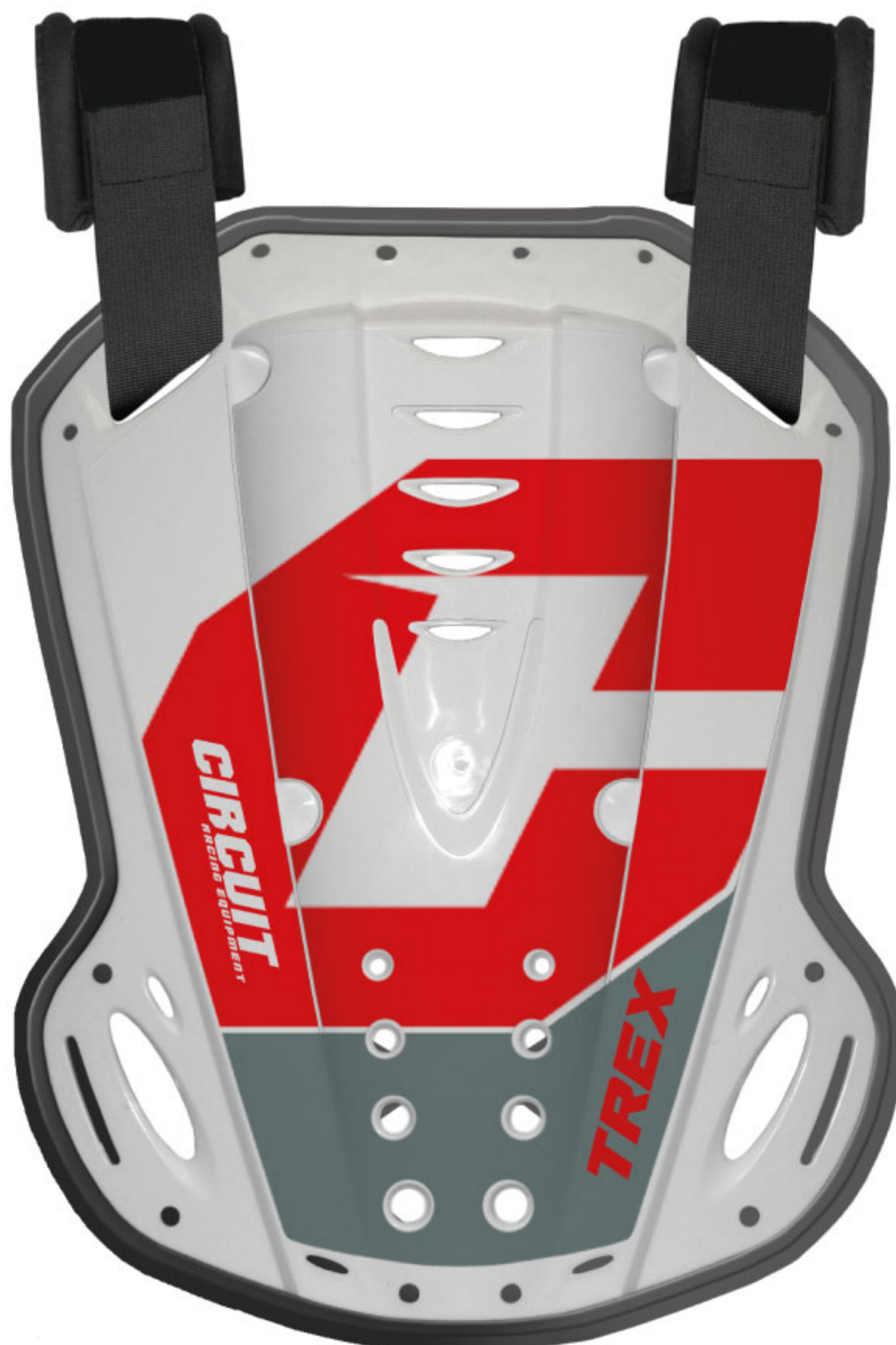

SMART 28

MATCH

Italian design with capacity of 28 liters.
Exclusive locking system with password and
Aluminum rack.
Fixing system that does not generate vibration.
Available in two fixing obkions developed by
Circuit: one with an exclusive fixing system
most suitable for tubular racks.

COLORS

BA007-001 CASE CIRCUIT SMART MATCH 28L LF - BLACK
BA007-024 CASE CIRCUIT SMART MATCH 28L LF - TITANIUM
BA008-001 CASE CIRCUIT SMART MATCH 28L SF - BLACK
BA007-024 CASE CIRCUIT SMART MATCH 28L SF - TITANIUM



CLEANER

Clean, Protect, and Shine Your Motorcycle. No need for a brush, cloth, bucket, or sponge. Safe for use on aluminum, anodized surfaces, seals, plastics, chrome surfaces, brakes, tires, chains, off-road and on-road motorcycles, ATVs, bicycles, engines, trailers, and general equipment. Proven formula, without acids, abrasives, or caustics.

CODE
LI001-098



DAKAR

Exclusive Italian design and modern visual finish that simulates carbon fiber. Fixation on the levers, not taking up space on the handlebars to fix. Protects the levers and brake cylinder. High resistance nylon adapter. Adapters and screws are included with the product. Produced especially for special motorcycles (imported) of Motocross and Enduro.

COLORS

2D1 PM DAKAR CAR/BK
2D2 PM DAKAR CAR/WT
2D4 PM DAKAR CAR/BL
2D6 PM DAKAR CAR/YE
2D7 PM DAKAR CAR/GN
2D9 PM DAKAR CAR/OR
2DA PM DAKAR CAR/FRD

UNIVERSAL

PM038-2D1 CAR/BK
PM038-2D2 CAR/WT
PM038-2D4 CAR/BL
PM038-2D5 CAR/CRD
PM038-2D6 CAR/YE
PM038-2D7 CAR/GN
PM038-2D9 CAR/OR
PM038-2DA CAR/FRD



FÊNIX

Developed for motorcycles:
Honda BROS and Yamaha
CROSSER.

Indicated for enduro,
supermoto and street bike.

Made of nylon with an
aesthetic finish that simulates
carbon fiber.

Applicable to all types of
handlebars and easy
to install.

IRON HANDLEBAR

PM079-211 BK/BK
PM079-212 BK/WT
PM079-213 BK/GY
PM079-214 BK/BL
PM079-216 BK/YE
PM079-217 BK/GN
PM079-219 BK/OR
PM079-21R BK/FYE
PM079-21V BK/RD

ALUMINUM HANDLEBAR

PM080-211 BK/BK
PM080-212 BK/WT
PM080-213 BK/GY
PM080-214 BK/BL
PM080-216 BK/YE
PM080-217 BK/GN
PM080-219 BK/OR
PM080-21R BK/FYE
PM080-21V BK/RD

FATBAR HANDLEBAR

PM081-211 BK/BK
PM081-212 BK/WT
PM081-213 BK/GY
PM081-214 BK/BL
PM081-216 BK/YE
PM081-217 BK/GN
PM081-219 BK/OR
PM081-21R BK/FYE
PM081-21V BK/RD



HANDGUARDS

CIRCUIT
RACING EQUIPMENT



VECTOR

Suitable for motocross and enduro. Highly resistant material (polypropylene shell).

Rod available in high strength nylon, aluminum or anodized aluminum.

Universal fixing for easy installation.

Protects the rider's hand and motorcycle levers against stone, mud and dust.

NYLON ROD

PM061-224 WT/BL
PM061-227 WT/GN
PM061-229 WT/OR
PM061-22AAWT/FRD
PM061-22A BL/WT
PM061-252 YE/BK
PM061-261 GN/BK
PM061-271 OR/BK
PM061-291 FRD/WT
PM061-2A2 TBL/WT
PM061-2AA2WT/TBL
PM061-2W1 PGN/BK



VECTOR CARBON

Suitable for motocross and enduro. Highly resistant material (polypropylene shell), aesthetic finish that simulates carbon fiber. Rod available in high strength nylon, aluminum or anodized aluminum. Universal fixing for easy installation. Protects the rider's hand and motorcycle levers against stone, mud and dust.



NYLON ROD

PM061-2D1	CAR/BK
PM061-2D2	CAR/WT
PM061-2D3	CAR/GY
PM061-2D4	CAR/BL
PM061-2D6	CAR/YE
PM061-2D7	CAR/GN
PM061-2D9	CAR/OR
PM061-2DA	CAR/FRD
PM061-2DAA	CAR/TBL
PM061-2DY	CAR/FPK
PM061-2DR	CAR/FOR
PM061-2DS	CAR/FYE



SX BICOMPONENTE

Highly resistant material (polypropylene). For light drum brake motorcycles. Protects rider's hands and levers of the bike against stone, mud and dust.

COLORS

PM033-001	BK
PM033-002	WT
PM033-003	GY
PM033-004	BL
PM033-006	YE
PM033-007	GN
PM033-008	OR
PM033-009	FRD
PM033-032	CRD
PM033-043	TBL
PM033-202	DRD/WT
PM033-212	BK/WT
PM033-216	BK/YE
PM033-217	BK/GN
PM033-219	BK/BRD
PM033-21V	BK/CRD
PM033-21U	BK/UMB
PM033-242	BL/WT
PM033-2A2	FRD/WT
PM033-2AA2	TBL/WT
PM033-2V2	CRD/WT



SX

DISC BRAKE

Suitable for Motocross, Rally and Enduro. Highly resistant material (polypropylene shell).

Rod available in high strength nylon or aluminum.

Universal fixing for easy installation.

Protects the rider's hands and motorcycle levers against stone, clay and dust.

DRUM BRAKE

Highly resistant material (polypropylene).

For light drum brake motorcycles.

Protects the rider's hand and motorcycle levers against stone, mud and dust.

DISC BRAKE

COLORS

PM030-001 BK
PM030-002 WT
PM030-003 GY
PM030-004 BL
PM030-006 YE
PM030-009 OR
PM030-011 FRD
PM030-032 CRD
PM030-043 TBL

DRUM BRAKE

COLORS

PM031-001 BK
PM031-003 GY
PM031-004 BL
PM031-006 YE
PM031-008 OR
PM031-009 FRD
PM031-032 CRD
PM031-043 TBL



P4 BICOMPONENTE

High impact resistance.
 Tested under severe conditions. Made of nylon with UV
 protection.
 Applicable to all types of handlebars and easy to install.

IRON HANDLEBAR

PM020-211 BK/BK
 PM020-212 BK/WT
 PM020-213 BK/GY
 PM020-216 BK/YE
 PM020-217 BK/GN
 PM020-219 BK/OR
 PM020-21V BK/CRD
 PM020-221 WT/BK
 PM020-224 WT/BL
 PM020-22AA WT/TBL
 PM020-22V WT/CRD
 PM020-21Y BK/PK

ALUMINUM HANDLEBAR

PM021-211 BK/BK
 PM021-212 BK/WT
 PM021-213 BK/GY
 PM021-216 BK/YE
 PM021-217 BK/GN
 PM021-219 BK/OR
 PM021-21V BK/CRD
 PM021-221 WT/BK
 PM021-224 WT/BL
 PM021-22AA WT/TBL
 PM021-22V WT/CRD
 PM021-21Y BK/PK

FATBAR HANDLEBAR

PM022-211 BK/BK
 PM022-212 BK/WT
 PM022-213 BK/GY
 PM022-216 BK/YE
 PM022-217 BK/GN
 PM022-219 BK/OR
 PM022-21V BK/CRD
 PM022-221 WT/BK
 PM022-224 WT/BL
 PM022-22AA WT/TBL
 PM022-22V WT/CRD
 PM022-21Y BK/PK



ALLOY_{SHORT}

Compound for better and more resistant raw material (polypropylene shell). Structure in polished aluminum or painted in black. Applicable to all types of handlebars and easy to install. Only one anchor bolt (on handlebar tip).



ALUMINUM HANDLEBAR 13,5mm

PM015-001 BK
 PM015-002 WT
 PM015-003 GY
 PM015-004 BL
 PM015-006 YE
 PM015-007 GN
 PM015-009 OR
 PM015-011 FRD
 PM015-032 CRD

QUADRICYCLE 15,8mm

PM016-001 BK
 PM016-002 WT
 PM016-003 GY
 PM016-004 BL
 PM016-007 GN
 PM016-009 OR
 PM016-011 FRD
 PM016-032 CRD

IRON HANDLEBAR 17,5mm

PM017-001 BK
 PM017-002 WT
 PM017-004 BL
 PM017-011 FRD
 PM017-032 CRD

ALLOY_{C/SLIDER}

Compound for better and more resistant raw material (polypropylene shell). Structure in polished aluminum or painted in black. Applicable to all types of handlebars and easy to install. Two anchorage point.



IRON HANDLEBAR 17,5mm

PM070-001 BK
 PM070-002 WT
 PM070-003 GY
 PM070-004 BL
 PM070-006 YE
 PM070-007 GN
 PM070-009 OR
 PM070-032 CRD

ALUMINUM HANDLEBAR 13,5mm

PM071-001 BK
 PM071-002 WT
 PM071-003 GY
 PM071-004 BL
 PM071-006 YE
 PM071-009 OR
 PM071-011 FRD
 PM071-032 CRD

FAT BAR HANDLEBAR 13,5mm

PM072-001 BK
 PM072-002 WT
 PM072-003 GY
 PM072-004 BL
 PM072-006 YE
 PM072-007 GN
 PM072-009 OR
 PM072-011 FRD
 PM072-032 CRD

ALLOY BICOMP

Totally innovative and modern design. Highly resistant material (polypropylene shell). Structure in polished aluminum or painted in black. Applicable to all types of handlebars and easy to install.



IRON HANDLEBAR 17.5mm

PM040-211 BK/BK
 PM040-212 BK/WT
 PM040-216 BK/YE
 PM040-217 BK/GN
 PM040-219 BK/OR
 PM040-21A BK/FRD
 PM040-21V BK/CRD
 PM040-224 WT/BL

ALUMINUM HANDLEBAR 13.5mm

PM041-211 BK/BK
 PM041-212 BK/WT
 PM041-216 BK/YE
 PM041-217 BK/GN
 PM041-219 BK/OR
 PM041-21A BK/FRD
 PM041-21V BK/CRD
 PM041-224 WT/BL

FATBAR HANDLEBAR 13.5mm

PM042-211 BK/BK
 PM042-212 BK/WT
 PM042-216 BK/YE
 PM042-217 BK/GN
 PM042-219 BK/OR
 PM042-21A BK/FRD
 PM042-21V BK/CRD
 PM042-224 WT/BL

BICOMP SHORT

Totally innovative and modern design. Highly resistant material (polypropylene shell). Structure in polished aluminum or painted in black. Applicable to all types of handlebars and easy to install. Only one anchor point (at the end of the handlebars).



IRON HANDLEBAR 17.5mm

PM048-211 BK/BK
 PM048-212 BK/WT
 PM048-215 BK/RD
 PM048-21A BK/FRD
 PM048-21V BK/CRD

ALUMINUM HANDLEBAR 13.5mm

PM046-211 BK/BK
 PM046-212 BK/WT
 PM046-215 BK/RD
 PM046-216 BK/YE
 PM046-217 BK/GN
 PM046-219 BK/OR
 PM046-21V BK/CRD
 PM046-224 WT/BL

FATBAR HANDLEBAR 15.88MM

PM047-212 BK/WT
 PM047-215 BK/RD
 PM047-219 BK/OR
 PM047-21A BK/FRD
 PM047-224 WT/BL

VENTURA

With an exclusive Italian design and carbon fiber finishing modern look. Impact resistance, with structure and circuit logo in high quality aluminum. Also with optional spoiler which increases hand protection area. Universal application and with version for big trail motorcycles. BMW GS1200 (2013 to 2019), HONDA CRF1000 AFRICA TWIN (all years) and KTM ADVENTURE 1290 (not tested in other models)

IRON HANDLEBAR

PM083-124 PM VENTURA CARB BK/TT FE
PM083-211 PM VENTURA CARB BK/BK FE

ALUMINUM HANDLEBAR

PM084-124 PM VENTURA CARB BK/TT AL
PM084-211 PM VENTURA CARB BK/BKAL
PM084-213 PM VENTURA CARB BK/GY AL

FATBAR HANDLEBAR

PM085-124 PM VENTURA CARB BK/TT FB
PM085-211 PM VENTURA CARB BK/BK FB

KTM ADVENTURE 1290

PM086-124 PM VENTURA CARB BK/TT KTM
PM086-211 PM VENTURA CARB BK/BK KTM

BMW GS 1200

PM087-124 PM VENTURA CARB BK/TT BMW
PM087-211 PM VENTURA CARB BK/BK BMW
PM087-213 PM VENTURA CARB BK/GY BMW

AFRICA TWIN

PM088-124 PM VENTURA CARB BK/TT AT
PM088-211 PM VENTURA CARB BK/BK AT



KIRA

LOCK-ON type handle, with handle coupled to pulley
No needs to use fixing wire or glue.
It has different throttle cable connectors for different off-road motorcycle models.
Left handle also features easy and quick fixing, with anodized aluminum ring for a secure hold.
It has a "diamond" design with hexagons.
Made of soft and comfortable material.
It has two materials, being the contact region with hands a high softness material, and in the extremities a harder material to hold. Eventual falls or hit on obstacles of the OFF-ROAD environment.
Italian design.

COLORS
MA016-23A GY/TI
MA016-2B1 GY/BK



CIRCUIT V

High performance handle. Two-component design, high-grip outer material, rigid inner material for attachment to the handlebar.
Micro piramids on all surface ensure much more grip.
Tips with "C" logo.

COLORS

- MA018-212 BK/WT
- MA018-213 BK/GY
- MA018-215 BK/RD
- MA018-216 BK/YE
- MA018-217 BK/GN
- MA018-219 BK/OR
- MA018-21Z BK/FBL



ELECTRA RACING

Designed for OFF-ROAD competition. It has diamonds of different sizes distributed randomly over the surface, providing high grip to the rider's hands. It has material with a more uniform design in the palm region to maintain comfort. High-grip outer material and harder inner material to maintain an hold grip on the bike.

COLORS

MA008-212	BK/WT
MA008-213	BK/GY
MA008-214	BK/BL
MA008-215	BK/RD
MA008-216	BK/YE
MA008-217	BK/GN
MA008-219	BK/OR
MA008-21Y	BK/PK
MA008-21Z	BK/FBL
MA008-242	BL/WT
MA008-252	RD/WT



JUPITER RACING

Produced with Italian rubber
(high grip material).
Suitable for competition motorcycles.
DIAMETER: E = 22 MM | D = 24 MM
DIMENSION: 117 MM

COLORS	RACING
MA042-212	BK/WT
MA042-213	BK/GY
MA042-215	BK/RD
MA042-216	BK/YE
MA042-217	BK/GN
MA042-219	BK/OR
MA042-21Y	BK/FPK
MA042-21Z	BK/FBL
MA042-242	BL/WT
MA042-252	RD/WT



RACING II

Produced with Italian rubber
(high grip material).
Suitable for competition motorcycles.
Opened tip to fit the handguard.
DIAMETER: E = 22 MM | D = 24 MM
DIMENSION: 117 MM

COLORS	RACING II
MA057-215	BK/RD



CIRCUIT I

Produced with high abrasion resistant material.
Fits perfectly in current accelerators.
HONDA BROS, XRE, YAMAHA CROSSER and similar.
DIAMETER: E = 22 MM | D = 24 MM
DIMENSION: 120 MM

COLORS

MA001-001	BK
MA001-002	GY
MA001-003	BL
MA001-004	RD

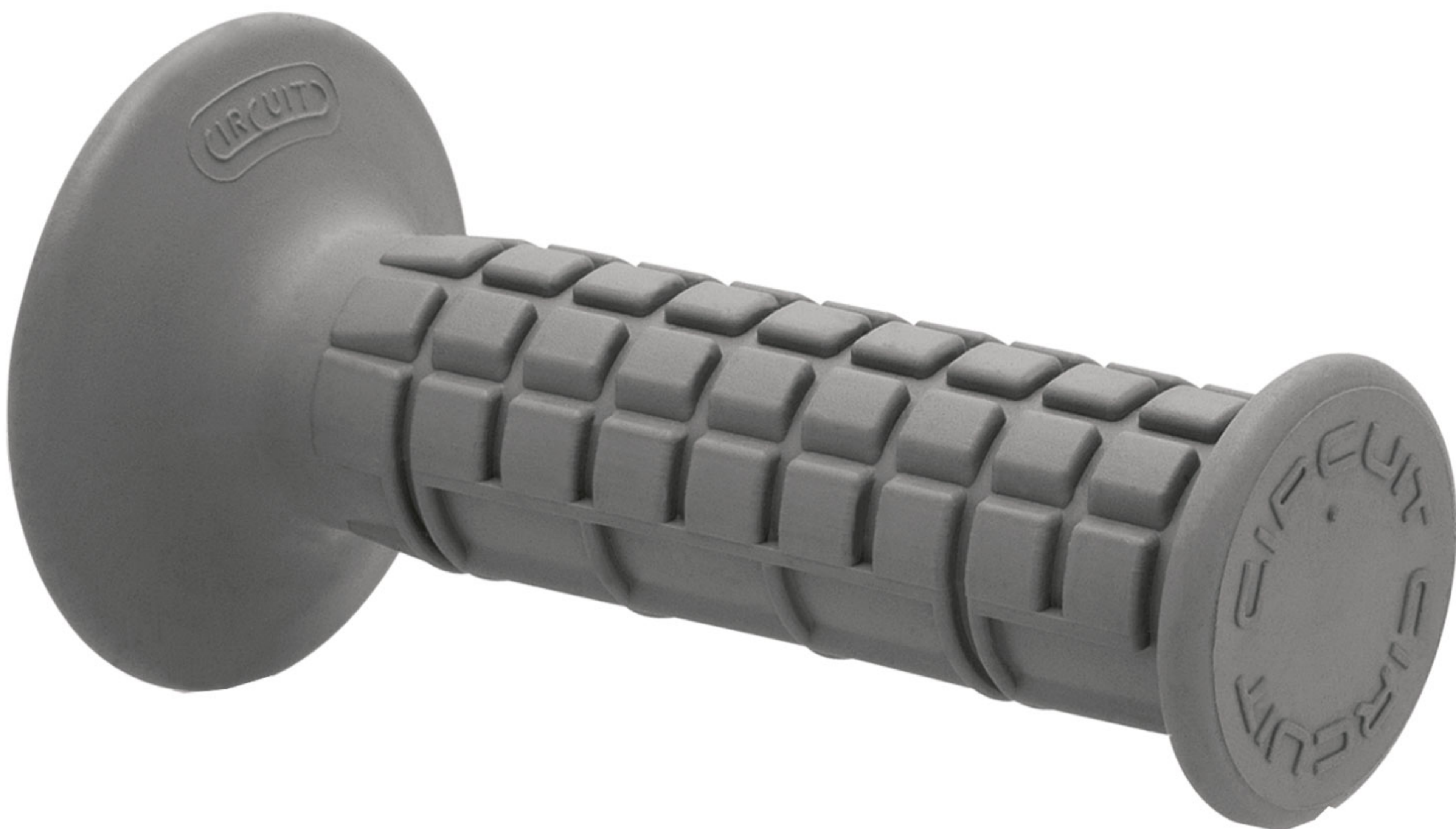

CIRCUIT II

Produced in gel rubber (high grip material).
Suitable for competition motorcycles.
Fits perfectly on current accelerators.
Developed following the trend of the world market.
Microdiamond texture and waffle grooves.
Includes stainless wire (for situations that require greater fixation).
HONDA BROS, XRE, YAMAHA CROSSER and similar.
DIAMETER: E = 22 MM | D = 24 MM
DIMENSION: 118 MM

COLORS

MA002-001 BK
MA002-003 GY
MA002-004 BL
MA002-005 RD

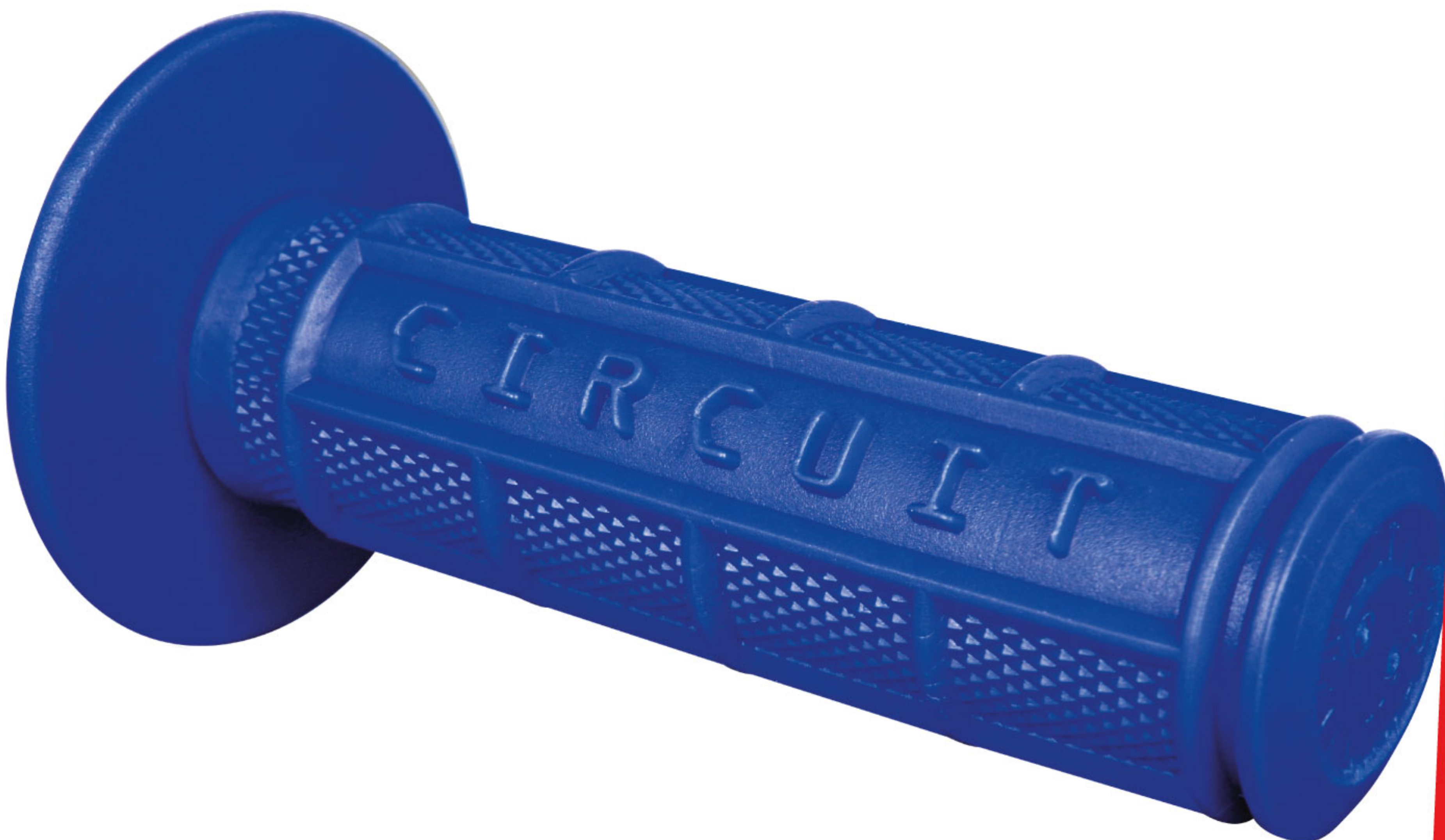

CIRCUIT III

Produced in gel rubber (high grip material).
Suitable for competition motorcycles.
It adapts perfectly to current accelerators.
Developed following the trend of the world market.
Microdiamond texture and part with waffle like grooves.
Included stainless steel wire (for situations that require strong fixation).
And also the version with exclusive NEOPRENE RINGS
In the black color.
DIAMETER: E = 22 MM I D = 24 MM
DIMENSION: 118 MM

COLORS

MA003-001 BK
MA003-002 WT
MA003-003 GY
MA003-004 BL
MA003-005 RD

WITH NEO RING

DIAMETER: E = 22 MM I D = 24 MM
DIMENSION: 118 MM
MA044-001 C/ NEO RING BK



CIRCUIT IV

Produced in gel rubber (high grip material).
Suitable for competition motorcycles.
Fits perfectly on today's accelerators.
Developed following the trend of the world market.
Microdiamond texture.
Includes stainless wire
(for situations that require greater fixation).
With specific slots for using the wire.
DIAMETER: E = 22 MM | D = 24 MM
DIMENSION: 117 MM

COLORS

MA005-001	BK
MA005-002	WT
MA005-003	GY
MA005-004	BL
MA005-005	RD
MA005-028	FYE
MA005-029	ORF
MA005-030	GNF
MA005-037	FPK
MA005-039	FBL



COBRA II

Produced in gel rubber (high grip material).
Suitable for off-road and on-road motorcycles.
Design that gives it softness and grip.
Includes stainless wire (for situations that require strong fixation).
DIAMETER: E = 22 MM I D = 24 MM
DIMENSION: 120 MM

COLORS
MA004-001 BK
MA004-003 GY
MA004-004 BL
MA004-005 RD



BALÍSTICO

Carbon look finishing surface.
For imported motorcycles (special)
motocross and enduro installation kit
sold separately.

COLORS

CD007-2D1	CAR/BK
CD007-2D2	CAR/WT
CD007-2D4	CAR/BL
CD007-2D6	CAR/YE
CD007-2D7	CAR/GN
CD007-2DS	CAR/OR
CD007-2DAA	CAR/TM

INSTALLATION KIT

RP108-BET	BETA RACING
RP108-CRF	HONDA CRF
RP108-KAW	KAWASAKI KX-F
RP108-KTM	KTM EXC/SXF
RP108-SUZ	SUZUKI RM-Z
RP108-TMR	TM RACING
RP108-YAM	YAMAHA YZF
RP108-HUS	HUSQVARNA
RP108-SHE	SHERCO
RP108-KW1	KAWASAKI KXF 450(2019 – 2022)

NYLON



CIRCUIT I

Suitable for Honda BX 150/200/300,
Honda SAHARA, Honda FALCON 400,
Honda XR200/600
Honda TORNADO 250, Honda NXR 125,
Yamaha XT225,
Yamaha XTZ 125, Yamaha DT200.

COLORS	
CD001-001	BK
CD001-002	WT
CD001-003	GY
CD001-004	BL
CD001-006	YE
CD001-007	GN
CD001-008	PU
CD001-032	CRD



COOL

Highly resistant material (polypropilene).
With holes for cooling
motorcycle heat.

120 MM X 760 MM

COLORS

PF012-001	BK
PF012-002	WT
PF012-004	BL
PF012-006	YE
PF012-007	GN
PF012-009	OR
PF012-011	FRD
PF012-032	CRD



STRIKE

Highly resistant material (polypropilene).

COLORS

PF002-001	BK
PF002-002	WT
PF002-004	BL
PF002-006	YE
PF002-007	GN
PF002-009	OR
PF002-032	CRD



C8

Highly resistant material (polypropilene).
120 MM X 760 MM

COLORS

PF001-001-C8	BK
PF001-002-C8	WT
PF001-004-C8	BL
PF001-006-C8	YE
PF001-007-C8	GN
PF001-032-C8	CRD



UNIVERSAL REAR

Highly resistant material (polypropylene).
It has UV protection that guarantees liveliness and conservation of its coloration. Inspired by the HONDA CRF 230.
For some motorcycle models or products you may require some adaptation.

NO SIDE HOLE

PF011-001	BK
PF011-002	WT
PF011-004	BL
PF011-006	YE
PF011-009	GN
PF011-032	CRD

SIDE HOLE

PF010-001	BK
PF010-002	WT
PF010-004	BL
PF010-006	YE
PF010-009	GN
PF010-032	CRD



STEALTH

Designed especially for supermoto.
Highly resistant material (polypropylene).
Made of two injected parts
once coupled are
an original piece with
modern design.

COLORS

PF004-001	SM BK
PF004-002	SM WT
PF004-003	SM GY
PF004-004	SM BL
PF004-006	SM YE
PF004-007	SM GN
PF004-009	SM OR
PF004-011	SM FRD
PF004-032	SM CRD
PF004-035	SM CRD
PF004-221	SM WT/BK
PF004-222	SM WT/WT
PF004-224	SM WT/BL
PF004-226	SM WT/YE
PF004-227	SM WT/GN
PF004-229	SM WT/OR
PF004-22A	SM WT/FRD
PF004-22V	SM WT/CRD



CRF 230 FRONT

Highly resistant material (polypropylene).
Suitable for HONDA CRF230.
90 MM X 760 MM

COLORS

PF016-001	BK
PF016-002	WT
PF016-004	BL
PF016-006	YE
PF016-007	GN
PF016-011	FRD
PF016-032	CRD



REAR

Highly resistant material (polypropylene).
With uv protection that guarantee the
Intensity and conservation
of its primary Colors.
Suitable for HONDA CRF 230.

CRISTAL LENS

PF014-001	BK/CRY
PF014-002	WT/CRY
PF014-004	BL/CRY
PF014-008	PU/CRY
PF014-011	FRD/CRY
PF014-032	CRD/CRY

RED LENS

PF015-001	BK/RD
PF015-002	WT/RD
PF015-004	BL/RD
PF015-008	PU/RD
PF015-009	OR/RD
PF015-011	FRD/RD
PF015-032	CRD/RD



BAGUS

Easy installation number plate in matte Polycarbonate.
 Made with polypropylene.
 Optical globe with polycarbonate lens, philips Lamp 12v of 2x3 5w filament.
 Rubber belts set to allow setting in different Diameter sticks. Ce and dot certificate.

COLORS

HL020-211	BK/BK
HL020-212	BK/WT
HL020-221	WT/BK
HL020-222	WT/WT
HL020-242	BL/WT
HL020-252	RD/WT
HL020-262	YE/WT
HL020-272	GN/WT
HL020-292	OR/WT
HL020-2A2	FRD/WT



POLICARBONATO TRANSLUCENT

COLORS

HL021-21E	BK/SM
HL021-22E	WT/SM



MANTIS

Highly resistant material (polypropylene).
 Led available with crystal or red lens.
 Includes bolt kit for universal fixing and
 Marking for assembly.

COLORS

- PT003-215 BK/RD
- PT003-211 BK/WT
- PT003-225 WT/RD
- PT003-221 WT/CR



CIRCUIT I

Suitable for off-road motorcycle with vintage Design. Highly resistant material (polypropylene).

COLORS

PN001-001	BK
PN001-002	WT
PN001-006	YE
PN001-007	GN
PN001-032	CRD

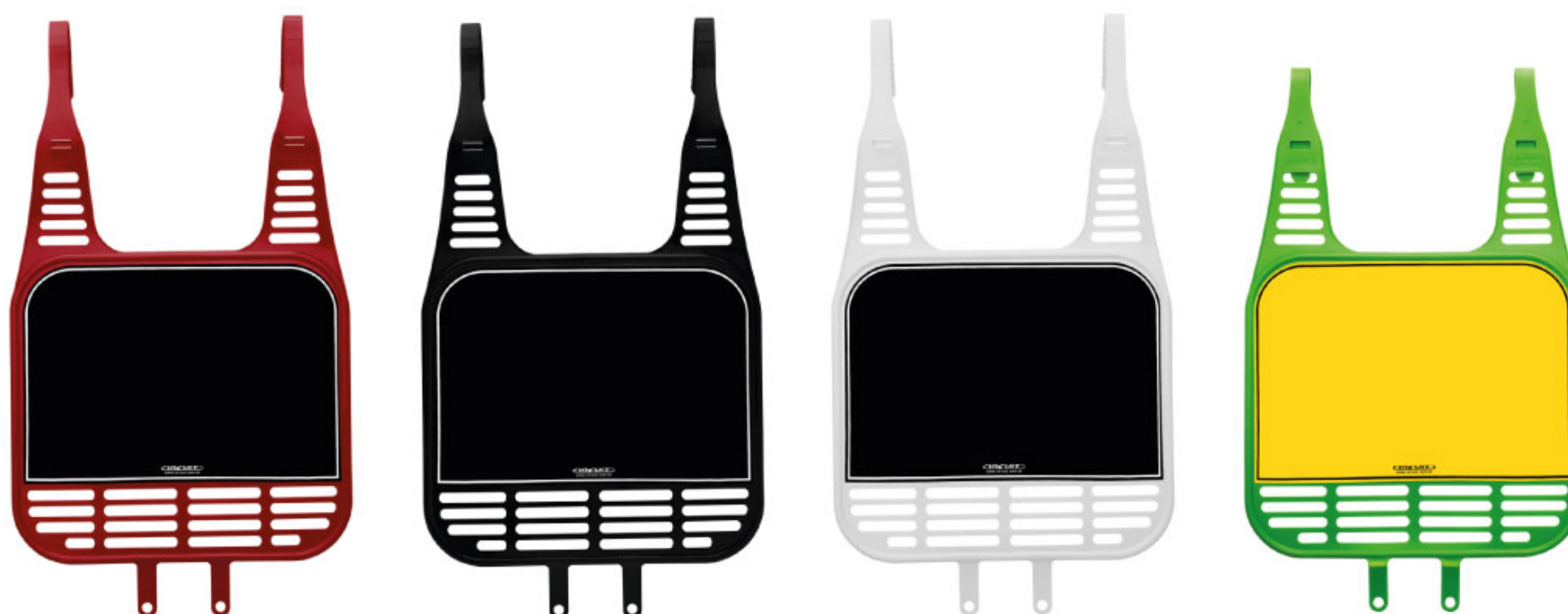

FUTURE

Suitable for honda crf 230 specifically.
Highly resistant material (polypropylene).

COLORS

PN005-214	BK/BL
PN005-216	BK/YE
PN005-21V	BK/CRD
PN005-221	WT/BK
PN005-224	WT/BL
PN005-226	WT/YE
PN005-001	BK
PN005-004	BL
PN005-006	YE
PN005-032	CRD



CLOSED

Suitable for off-road motorcycle, ideal for competitions. Highly resistant material (Polypropylene).

- COLORS**
- PN004-001 BK
 - PN004-004 BL
 - PN004-006 YE
 - PN004-007 GN
 - PN004-009 OR
 - PN004-032 CRD



CRF 230

Suitable for Honda CRF 230 specifically. Highly resistant material (polypropylene).

- COLORS**
- HO009-001 BK
 - HO009-002 WT
 - HO009-004 BL
 - HO009-006 YE
 - HO009-011 FRD
 - HO009-032 CRD



FAST THROTTLES 2 STROKE

With injected nylon tube and pulley with fiber. Adjustable and easy to install. Enables rapid and precise acceleration, reaching maximum power only 1/4 loop. Suitable for 2-stroke motorcycles. Throttle cable no available (sold separately).

COLORS

CA001-001 FAST THROTTLE 2T
CIRCUIT RACING BK



FAST THROTTLES 4 STROKE

With injected nylon tube and pulley with fiber. Adjustable and easy to install. Enables rapid and precise acceleration, suitable for 4-stroke motorcycles. Throttle cable no available (Sold separately).

COLORS

CA005-001 FAST THROTTLE 4T
RACING BK
CA005-005 FAST THROTTLE 4T
RACING RD



KIT CABLE 4 STROKE UNIVERSAL

Designed and produced 100% in Italy, exclusively recommended for use with the Circuit 4-Stroke Quick Throttle.

CODE

CA007-098 KIT CABLE 4T UNIVERSAL

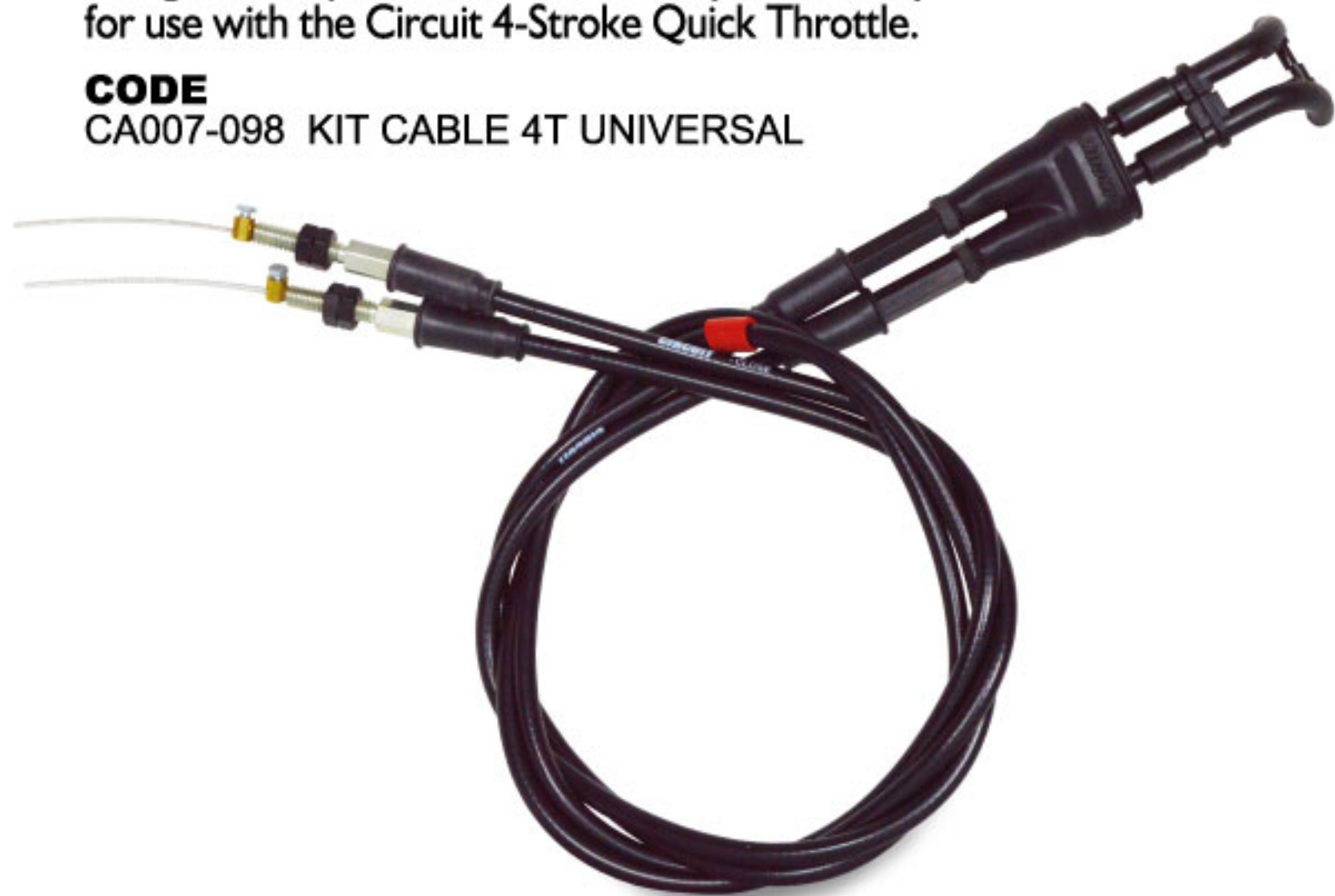

CRF 230 CABLE KIT

Indicated To Be Used Exclusively With The Circuit 4-stroke Quick Throttle On The Crf. Designed And Produced 100% In Italy.

CODE

CA006-098 CRF230 CABLE KIT



FAST THROTTLE CABLE 2T UNIVERSAL

CODE

CA003-098 KIT CABLE
RAPID UNIV NEN



SMALL HIGH

Produced in Italy and manufactured
in ERGAL 7075 T6 aluminum.
Suitable for motorcycles between 50cc and 85cc.
Dimension: 73 cm



COLORS
AC016-023 AL

LOW

Made in Italy
It is manufactured in ERGAL 7075 T6 Aluminum.
Suitable for motorcycles between 125cc and 450cc.
Dimension: 80,5cm



COLORS
AC017-023 AL
AC017-024 TT
AC017-025 GD



SMALL HIGH

Handlebar made in Italy, available in several colors and folds.
Custom sale.

CODE
 HB001 ALU 7003 HANDLEBAR WITH CROSS BAR Ø 22 MM
 HB002 ERGAL HANDLEBAR 7075 WITH CROSS BAR Ø 22 MM
 HB004 ERGAL 7075 HANDLEBAR WITH CROSS BAR Ø 28.6 MM
 HB005 ERGAL 7075 HANDLEBAR WITHOUT CROSS BAR Ø 28.6 MM



ACCESSORIES

Anticorodal 6082 handlebar adapter kit oversize Ø 28.6 mm.
Complete with 8 fixing screws.

CODE
 HB013-001 STANDARD
 HB014-001 + 10 MM
 HB015-001 + 20 MM



Riser kit in anticorodal 6082. Includes 4 fixing screws.

CODE
 HB010 + 10 MM Ø 22 MM
 HB011 + 20 MM Ø 22 MM
 HB012 + 20 MM Ø 28 MM

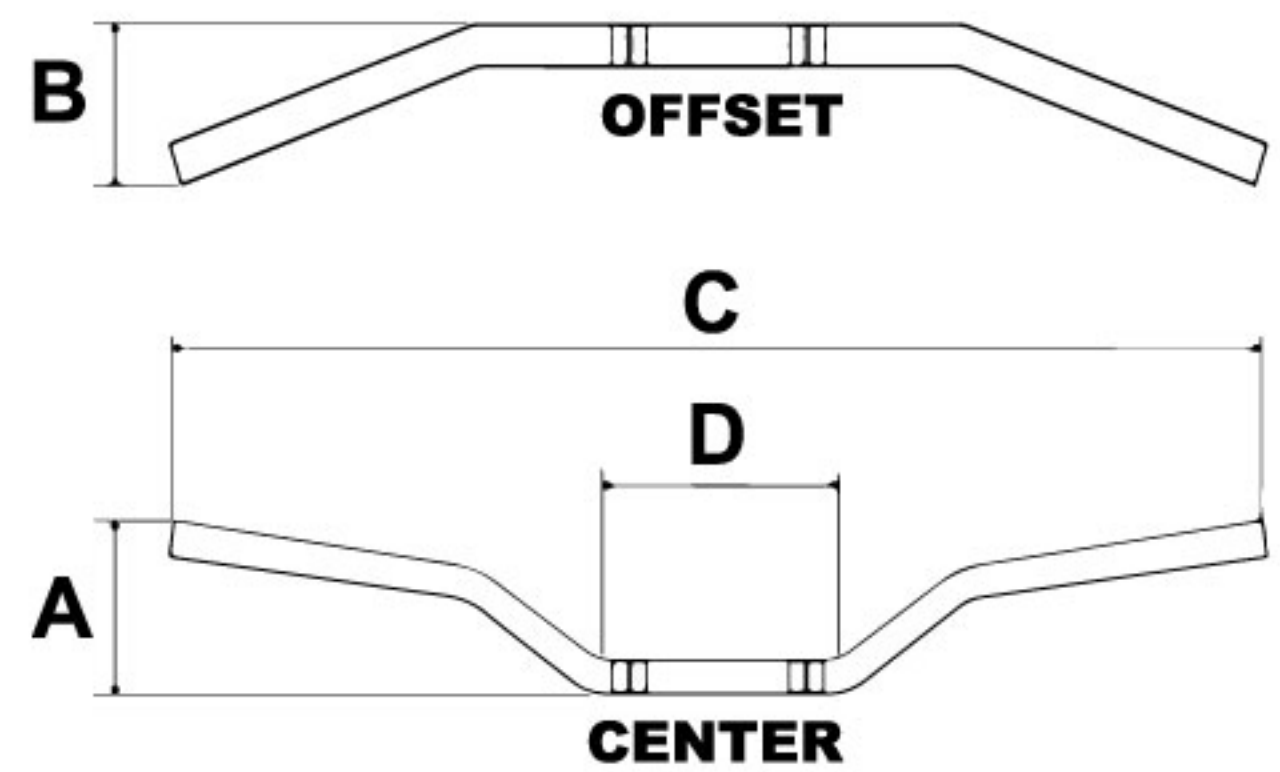

FOLD 11:	FOLD 17:	FOLD 99:
A = 120 MM	A = 110 MM	A = 90 MM
B = 54 MM	B = 50 MM	B = 45 MM
C = 800 MM	C = 800 MM	C = 805 MM
D = 145 MM	D = 145 MM	D = 145 MM

L.11

Tested and approved by
The best Brazilians pilots.
Indicated for fat bar type handlebars.

COLORS

HP011-EQP-WT	WT
HP011-EQP-BK	BK
HP011-EQP-VMF	VMF



CIRCUIT L.9

Made of polyurethane
Dimension: 245 mm

COLORS

HP004-009	OR
HP004-21R	BK/RDE
HP004-22AA	BK/BLTM
HP004-EQP-BC	EQP WH
HP004-EQP-PT	EQP BK
HP004-EQP-VMF	EQP YEE
HP004-VDE	GNE



MX3

Made in foam
and covered by vinyl.
Dimension: 230 mm

COLORS

HP016-215
HP016-216
HP016-217
HP016-219
HP016-21R
HP016-22AA
HP016-241



FORK BOOTS

Protects the motorcycle fork against dust, mud and stones, prolonging its useful life. Produced with resistant and durable material (Flexible pvc).



FORK BOOTS

10 FOLDS

Suitable for Honda POP 100.

COLORS

SS006-001 BK
SS006-004 BL
SS006-005 RD
SS006-006 YE

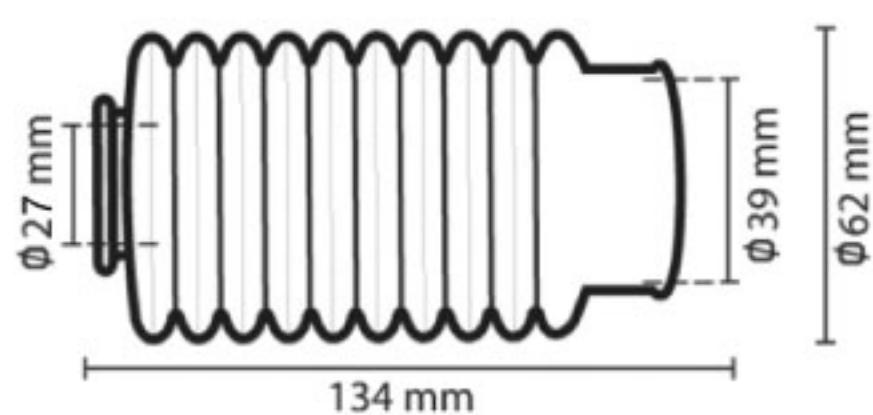

11 FOLDS

Suitable for: Honda TWISTER, Honda STRADA, Honda TITAN, Yamaha RD135, Yamaha YBR, Factor 125, Fazer 250, Honda CG 125, Fan 125, Cargo, CB 300.

COLORS

SS001-001 BK
SS001-003 GY
SS001-004 BL
SS001-005 RD
SS001-006 YE
SS001-016 TGN
SS001-029 FOR
SS001-030 FGN

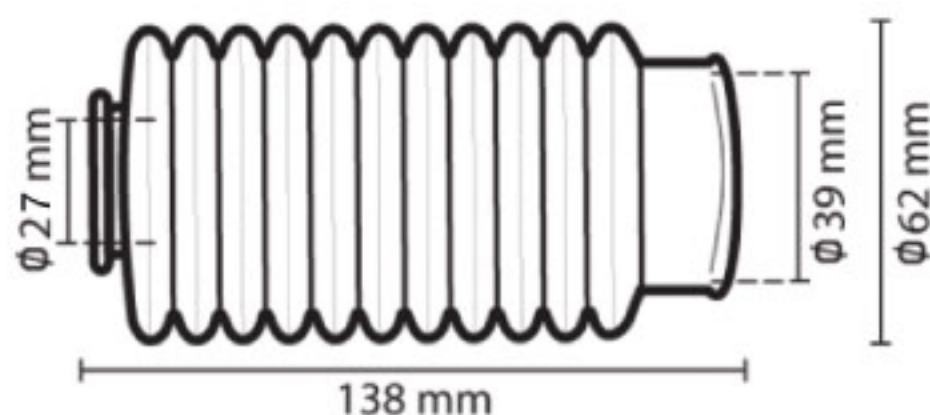

13 FOLDS

Suitable for: Honda TWISTER, Honda STRADA, Honda TITAN, Yamaha RD135, Yamaha YBR, Factor 125, Fazer 250, Honda CG125, Fan 125, Cargo, CB 300.

COLORS

SS007-001 BK
SS007-004 BL
SS007-005 RD
SS007-006 YE

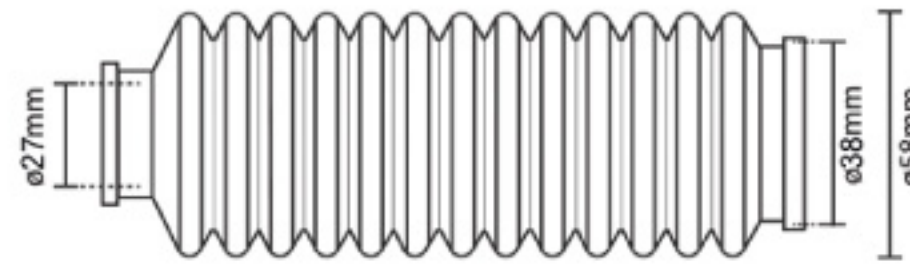

ADAPTERS



COLORS

SS10-001 2009 - 2014
SS10-004 2009 - 2014
SS10-005 2009 - 2014



COLORS

SS12-001 UNIVERSAL CG 125
SS12-004 UNIVERSAL CG 125
SS12-005 UNIVERSAL CG 125



COLORS

SS13-001 UNIVERSAL CG 150/160
SS13-004 UNIVERSAL CG 150/160
SS13-005 UNIVERSAL CG 150/160

18 FOLDS

Suitable for CROSSER 150, BROS 125 e XTZ 125.

COLORS

SS002-001 BK
SS002-003 GY
SS002-004 BL
SS002-005 RD
SS002-006 YE
SS002-029 FOR
SS002-030 FGN

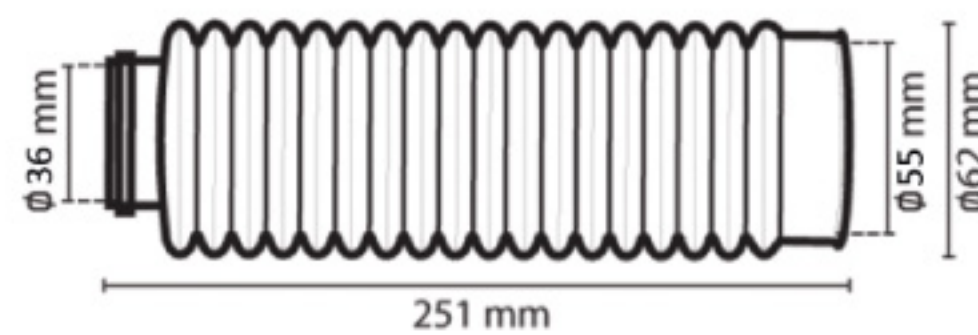

21 FOLDS

Suitable for: BROS 150 a partir de 2009, BROS 160 e XRE 190.

COLORS

SS009-001 BK
SS009-003 GY
SS009-004 BL
SS009-005 RD
SS009-006 YE
SS009-029 FOR
SS009-030 FGN

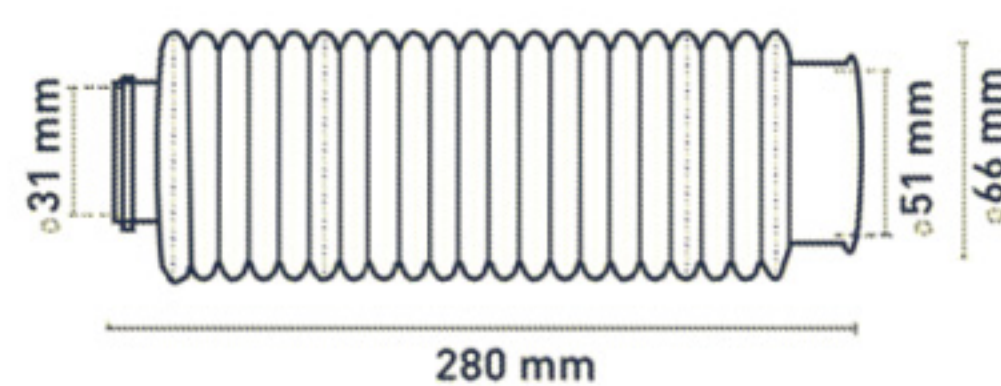

24 FOLDS

Suitable for:
Honda CRF 230, TTR 230, XLX 350,
DT 200, NX 200, XR 200, XL 250,
SAHARA 350, TORNADO,
TDM, SUNDOWN STX, TÉNÉRÉ 250
e LANDER 250.

COLORS	
SS003-001	BK
SS003-003	GY
SS003-004	BL
SS003-005	RD
SS003-006	YE
SS003-029	FOR
SS003-030	FGN

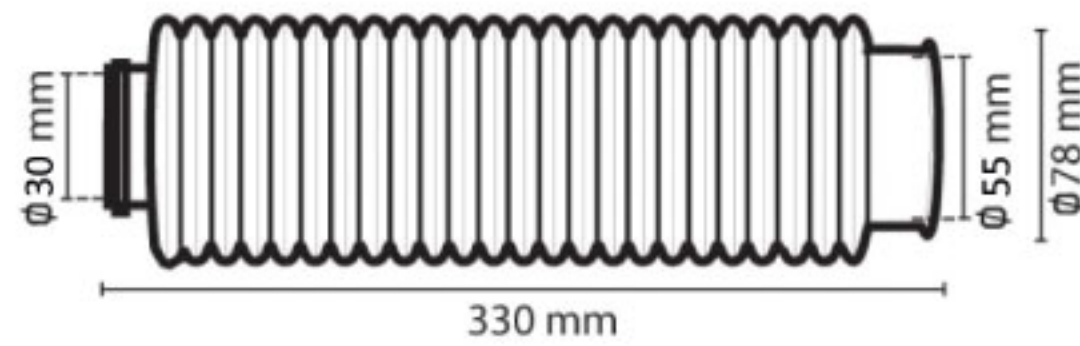

32 FOLDS

Suitable for: XR 250/400/600/650,
DR 350/650/800, KLX 250/400 e
XT 600/660, TENERÉ 250/600/660.

COLORS	
SS004-001	BK
SS004-004	BL
SS004-005	RD
SS004-006	YE
SS004-029	FOR
SS004-030	FGN

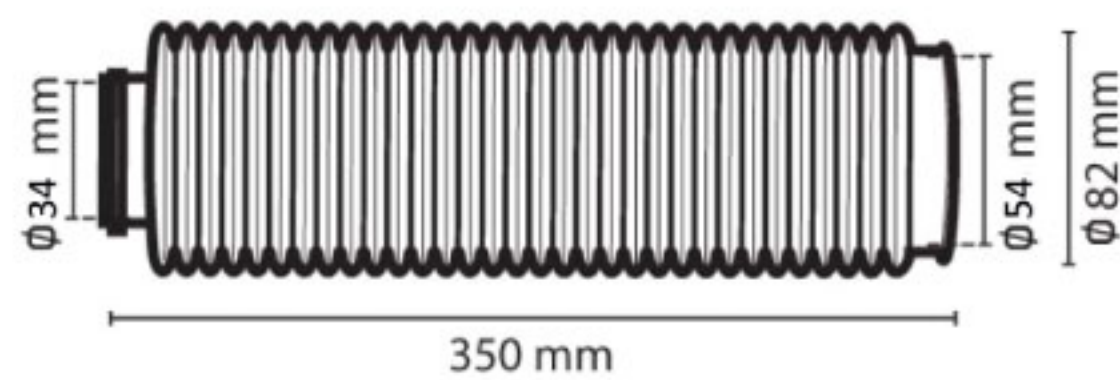

32 FOLDS XL

Suitable for:
XR 400/600/650, DR 350/650/800,
KLX 250/400, XT 600/660,
XTZ 750, TENERÉ 600/660

COLORS	
SS005-001	BK
SS005-003	GY
SS005-004	BL
SS005-005	RD
SS005-006	YE
SS005-029	FOR
SS005-030	FGN

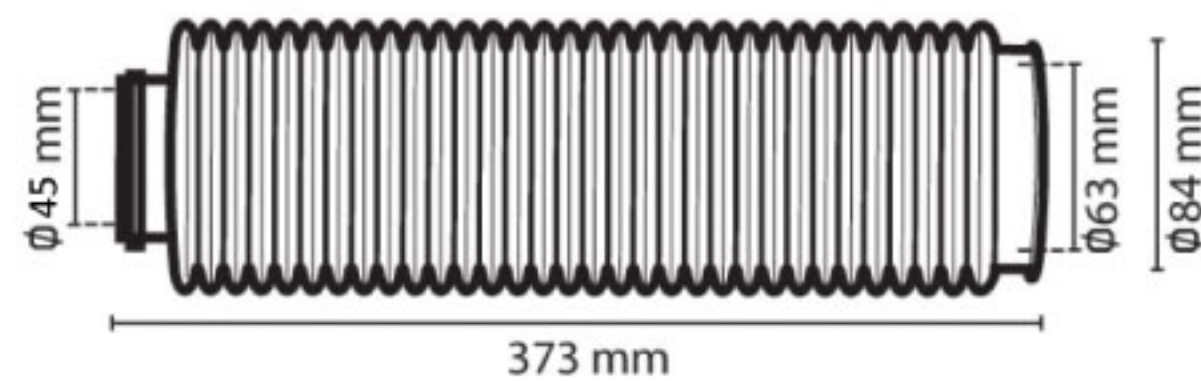

FRAME GUARDS CRF 230

Especially suitable for honda crf 230.
Produced in polypropylene. Easy Installation.
Exclusive design that conveys the same
Aggressiveness and sportiness of the lines
HONDA CRF 230.

COLORS

FG002-001 PROT FRAME CRF BK
FG002-002 PROT FRAME CRF WT
FG002-011 PROT FRAME CRF FRD



ENGINE GUARDS CRF

With exclusive italian design, noble
Brushed aluminum finish with high quality welds.
Developed especially for motorcycles
HONDA CRF 230 of all years.

COLORS

CM001-098 PROT MOTOR CRF AL



REFLEX GEAR

JERSEY

Entirely made with materials of very high quality. Made from 100% breathable polyester and of high tenacity.
S - M - L - XL - XXL

PANTS

Condura dupont, material certified to have abrasion resistance and 30% with nylon top quality. 100% lining made in nylon. It has a system of rubber adjustment natural and certified according to the rith rules. Fabric printed by sublimation with non-ecological inks polluting and non-toxic.
36 - 38 - 40 - 42 - 44 - 46 - 48



GEAR OFF ROAD

CIRCUIT
RACING EQUIPMENT



JERSEY
TS136-001 BK
PANTS
TS137-001 BK

JERSEY
TS136-028 FYE
PANTS
TS137-028 YE



JERSEY
TS136-039 FBL
PANTS
TS137-039 FBL

JERSEY
TS136-005 OR
PANTS
TS137-005 OR

REFLEX GEAR

TM RACING

PANTS
36 - 38 - 40 - 42 - 44 - 46 - 48

JERSEY
S - M - L - XL - XXL

GLOVES
S - M - L - XL
CUSTOM SALE



JERSEY
TS136-043



GLOVES
TS138-043

PANTS
TS137-043



JACKET ENDURO

Custom enduro racing jacket with graphics
Circuit equipment.
Made of windtex, with detachable sleeves and convenient pockets.
CUSTOM SALE.

CODE
TS100-098



JERSEY RACE

Cross/enduro racing jersey
Customized with circuit graphics
Equipment.
Also available perforated for the summer season.
Ideal for teams and motorcycle clubs.
CUSTOM SALE.

CODE
TS043-098



GILET

Cross/enduro racing vest
custom, cordura.
Ideal for teams and motorcycle clubs.
CUSTOM SALE.

CODE
TS101-098



C84 DEFENDER PROTECTOR

Allows the use of a cervical protector.
Quick and easy fixing
air vents
shoulder fit
side adjustment
extreme comfort



COLORS

PR022-001 CHEST PROTECTOR CIRCUIT DEFENDER BK
PR022-002 CHEST PROTECTOR CIRCUIT DEFENDER WT





CHEST PROTECTOR

CIRCUIT
RACING EQUIPMENT

QUANTUM GOGGLES

Quantum goggles are designed to give you the best possible eye protection for motorcycling activities. Please read the following instructions carefully and keep this leaflet in a safe place at your disposal.



QUANTUM
MX GOGGLES



QUANTUM GOGGLES



COLORS

- GO001-251 GOGGLES MOTOCROSS CIRCUIT QUANTUM - N RD/BK
- GO001-265 GOGGLES MOTOCROSS CIRCUIT QUANTUM - N YE/RD
- GO002-21K GOGGLES MOTOCROSS CIRCUIT QUANTUM - BK/GD
- GO002-264 GOGGLES MOTOCROSS CIRCUIT QUANTUM - YE/BL
- GO003-015 GOGGLES LENS MOTOCROSS QUANTUM - N
- GO004-015 GOGGLES LENS MOTOCROSS QUANTUM



ALUMINUM ROD KIT VECTOR

Spare aluminum rods Vector hand guard. Available in colors or pure aluminum.

COLORS

RP027-001 KIT HASTE AL VECTOR BK
 RP027-004 KIT HASTE AL VECTOR BL
 RP027-021 KIT HASTE AL VECTOR GD
 RP027-098 KIT HASTE AL VECTOR AL

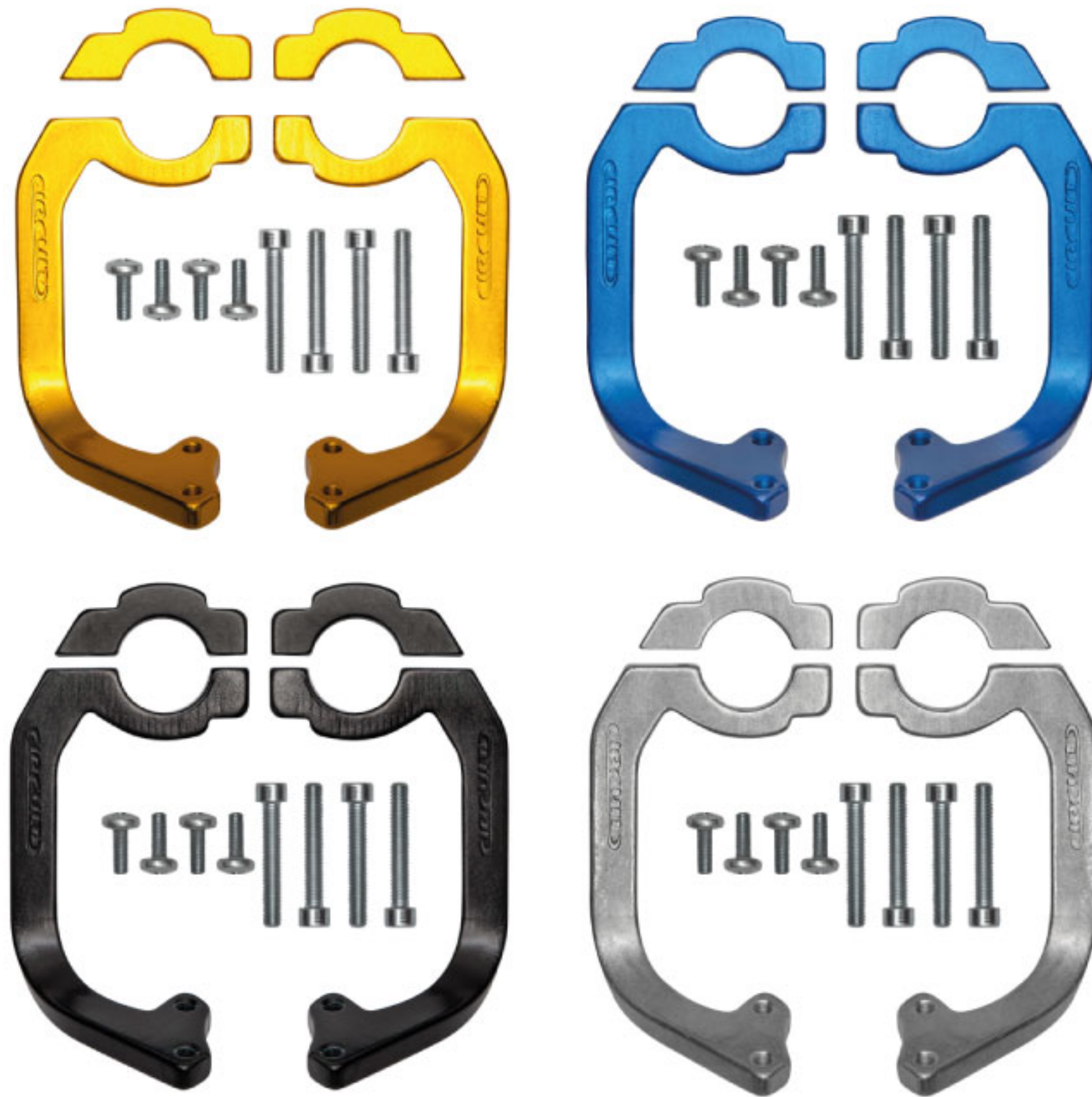

PLASTIC ROD KIT VECTOR

Plastic rods made of nylon. Indicated for handguards Vector and SX bicomponent.

CODE
 RP029-001 KIT HASTE VEC SX BK



ROD 9

CODE
 RP070-098 KIT HASTE 9 CIRCUIT 28MM
 RP071-098 KIT HASTE 9 CIRCUIT 32MM



BRACKETS 28MM

Suitable for fhs, alloy, p4 and fênix hand protectors. Clamp kit compatible with all models conical handlebar with 28.6 mm external diameter.

CODE
 RP021-098 KIT BRACKETS CIRCUIT 28MM
 RP003-098 KIT BRACKETS FHS PRO TAPER



ALMA BRACKETS

Split clamps.
Indicated for iron and aluminum handlebar.
Produced in polished aluminum.

CODE
RP002-098 KIT BRACKETS ALMA



ADAPTERS

Suitable for hand protectors in alma and alloy models. Produced in polished aluminum.

CODE
RP009-098 KIT ADAPTERS CIRCUIT ALMA/ALLOY



ADAPTERS P4

Installation kit for p4 hand guard aluminum handlebar.

CODE
RP008-098 KIT ADAP AL BK NEN



SLIDER

Indicated to protect and prolong the useful life of the metal core of the hand protectors in the alloy and alloy short models. Prevents possible scratches on the aluminum core. Produced in polypropylene.

ALLOY E ALLOY SHORT
RP031-001 BK



COVER GRIP

Resistant to abrasion and indicated to give aesthetic finishing to the grip. Made of abs material. Made of vinyl. Protects the handle surface against oil, grease and dirt during mechanical maintenance of the motorcycle.

COLORS
AM002-098 PROT MANOPLA NEN
AM002-FCB PROT MANOPLA GRIPS FCB
AM002-001 PROT MANOPLA GRIPS BK
AM002-TMR PROT MANOPLA GRIPS WT/TBL



CARPET

RACING

Ecologically correct product, made in Compliance with european standards, mandatory use of mats of this type in the racing pits. Its special material does not allow the oil to be absorbed by the ground.

MEASURE: 2,4M X 1M

COLORS
ZZ013-001



TENT

CIRCUIT POP-UP

Made of highly resistant polyester. Light and easy to assemble. It has support Structures made of aluminum and accompanies stakes for fixing in the ground.

Sidewalls made from the same fabric as the tent can be purchased separately.

MEASURE: 3M X 3M

CUSTOM SALE

COLORS

TD003-001	BK
TD003-003	GY
TD003-004	BL



CUBIC STAND

Made of highly resistant plastic.
Composed of: 01 plastic support and 01 pair of sandblasted steel legs. Painted with epoxy paint, high resistance, durability and excellent aesthetic finish. It has a central opening to facilitate the oil change. It has side compartments for adding small parts and screws.

CROSS/ENDURO

HEIGHT 42 CM

SM001-212 BK/WT
SM001-242 BL/WT
SM001-2V2 CRD/WT
SM001-292 OR/BK

SUPERMOTO

HEIGHT 37 CM

SM003-212 BK/WT
SM003-242 BL/WT
SM003-2V2 CRD/WT

MINIMOTO

HEIGHT 33 CM

SM002-242 BL/WT



CUBIC CARPET

Complementary product of the cubic easel.
Made to reduce the slip of the bike on the easel.
Felt-like material. It absorbs oil as specified by european standards.

COLORS

ZZ014-099



TRACK MARKERS

Made of ultra resistant material.
Indicated for use in motocross, enduro,
veloterra, downhill, bike paths, among
Others. Suggested spacing between flags
From 3 to 5 meters.
It can be reused countless times.

COLORS
ZZ009-006 YE



BUCKET

Made of polypropylene with aluminum handles
Reinforced. Versatile and functional.
Suitable for mechanical workshops, racing,
use domestic, among others.
Capacity: 10L

COLORS
ZZ003-001 BK



ON ROAD



INDEX

72

HANDGUARDS

85

GRIPS

97

DISC COVER

100

FENDERS

104

HEADLIGHTS

105

TAILLIGHTS

106

TURN SIGNAL

107

HANDLEBARS

109

BAR PADS

111

CUSTOM LINE

114

FORK BOOTS

117

MOTORCYCLE CASE

119

SPARE PARTS

122

ACCESSORIES

124

BIKE GRIPS

133

BIKE GEAR

134

BIKE HANDGUARDS

135

BIKE ACCESSORIES

136

CASUAL LINE

FÊNIX

Developed for motorcycles:
Honda BROS and Yamaha
CROSSER.

Indicated for enduro,
supermoto and street bike.

Made of nylon with an
aesthetic finish that simulates
carbon fiber.

Applicable to all types of
handlebars and easy
to install.

IRON HANDLEBAR

PM079-211	BK/BK
PM079-212	BK/WT
PM079-213	BK/GY
PM079-214	BK/BL
PM079-216	BK/YE
PM079-217	BK/GN
PM079-219	BK/OR
PM079-21R	BK/FYE
PM079-21V	BK/RD

ALUMINUM HANDLEBAR

PM080-211	BK/BK
PM080-212	BK/WT
PM080-213	BK/GY
PM080-214	BK/BL
PM080-216	BK/YE
PM080-217	BK/GN
PM080-219	BK/OR
PM080-21R	BK/FYE
PM080-21V	BK/RD

FATBAR HANDLEBAR

PM081-211	BK/BK
PM081-212	BK/WT
PM081-213	BK/GY
PM081-214	BK/BL
PM081-216	BK/YE
PM081-217	BK/GN
PM081-219	BK/OR
PM081-21R	BK/FYE
PM081-21V	BK/RD



FHS LED

Exclusive led lighting. Guarantees a better visibility
Of the motorcyclist during day and night.
Universal installation system.
Design inspired by the most modern lighting concept.
Easy electrical installation.

IRON HANDLEBAR

PM035-001 BK
PM035-002 WT

ALUMINUM HANDLEBAR

PM036-001 BK
PM036-002 WT

FATBAR HANDLEBAR

PM037-001 BK
PM037-002 WT



STREET

Exclusive design with two fastening
Pointers.
Made of nylon with uv protection.
Suitable for HONDA TWISTER, YAMAHA FAZER,
YAMAHA LANDER and alike.

COLORS

PM050-211 BK/BK
PM050-214 BK/BL
PM050-216 BK/YE
PM050-21C BK/SL
PM050-21V BK/CRD
PM050-221 WT/BK
PM050-224 WT/BL
PM050-22V WT/CRD



VENTURA

With an exclusive Italian design and carbon fiber finishing modern look. Impact resistance, with structure and circuit logo in high quality aluminum. Also with optional spoiler which increases hand protection area. Universal application and with version for big trail motorcycles. BMW GS1200 (2013 to 2019), HONDA CRF1000 AFRICA TWIN (all years) and KTM ADVENTURE 1290 (not tested in other models)

IRON HANDLEBAR

PM083-124 PM VENTURA CARB BK/TT FE
PM083-211 PM VENTURA CARB BK/BK FE

ALUMINUM HANDLEBAR

PM084-124 PM VENTURA CARB BK/TT AL
PM084-211 PM VENTURA CARB BK/BKAL
PM084-213 PM VENTURA CARB BK/GY AL

FATBAR HANDLEBAR

PM085-124 PM VENTURA CARB BK/TT FB
PM085-211 PM VENTURA CARB BK/BK FB

KTM ADVENTURE 1290

PM086-124 PM VENTURA CARB BK/TT KTM
PM086-211 PM VENTURA CARB BK/BK KTM

BMW GS 1200

PM087-124 PM VENTURA CARB BK/TT BMW
PM087-211 PM VENTURA CARB BK/BK BMW
PM087-213 PM VENTURA CARB BK/GY BMW

AFRICA TWIN

PM088-124 PM VENTURA CARB BK/TT AT
PM088-211 PM VENTURA CARB BK/BK AT



VECTOR

Suitable for motocross and enduro. Highly resistant material (polypropylene shell).
Rod available in high strength nylon, aluminum or anodized aluminum.
Universal fixing for easy installation.
Protects the rider's hand and motorcycle levers against stone, mud and dust.

NYLON ROD

PM061-224 WT/BL
PM061-227 WT/GN
PM061-229 WT/OR
PM061-22AAWT/FRD
PM061-22A BL/WT
PM061-252 YE/BK
PM061-261 GN/BK
PM061-271 OR/BK
PM061-291 FRD/WT
PM061-2A2 TBL/WT
PM061-2AA2WT/TBL
PM061-2W1 PGN/BK



VECTOR CARBON

Suitable for motocross and enduro. Highly resistant material (polypropylene shell), aesthetic finish that simulates carbon fiber. Rod available in high strength nylon, aluminum or anodized aluminum. Universal fixing for easy installation. Protects the rider's hand and motorcycle levers against stone, mud and dust.



NYLON ROD

PM061-2D1	CAR/BK
PM061-2D2	CAR/WT
PM061-2D3	CAR/GY
PM061-2D4	CAR/BL
PM061-2D6	CAR/YE
PM061-2D7	CAR/GN
PM061-2D9	CAR/OR
PM061-2DA	CAR/FRD
PM061-2DAA	CAR/TBL
PM061-2DY	CAR/FPK
PM061-2DR	CAR/FOR
PM061-2DS	CAR/FYE



VECTOR ROD SCOOTER

The most wanted product between everyday and Off-road motorcycles, now ready to equip your Scooter. Has metal rods with resistant paint. Fixed in the mirrors bracket. Protects against cold, rain and stones. Matte finish with carbon type texture. Included installation kit with screws.

COLORS

PM064-2D1 CAR/BK
PM064-2D2 CAR/WT
PM064-2D3 CAR/GY
PM064-2D4 CAR/BL
PM064-2DA CAR/FRD



DAKAR ROD UNIVERSAL

Universal application rod with rigid structure that allows best high speed protector stability. Made of high resistance and durability material. Has high resistance to weather as sun, rain, cold etc. With easy installation, only a small space is needed handlebar to coupling the rod. Indicated for ON-ROAD and OFF-ROAD motorcycles.

COLORS

PM038-2D1 CAR/BK
PM038-2D2 CAR/WT
PM038-2D4 CAR/BL
PM038-2D5 CAR/RD
PM038-2D6 CAR/YE
PM038-2D7 CAR/GN
PM038-2D9 CAR/OR
PM038-2DA CAR/FRD



ALLOY_{SHORT}

Compound for better and more resistant raw material (polypropylene shell). Structure in polished aluminum or painted in black. Applicable to all types of handlebars and easy to install. Only one anchor bolt (on handlebar tip).



ALUMINUM HANDLEBAR 13,5mm

PM015-001 BK
 PM015-002 WT
 PM015-003 GY
 PM015-004 BL
 PM015-006 YE
 PM015-007 GN
 PM015-009 OR
 PM015-011 FRD
 PM015-032 CRD

QUADRICYCLE 15,8mm

PM016-001 BK
 PM016-002 WT
 PM016-003 GY
 PM016-004 BL
 PM016-007 GN
 PM016-009 OR
 PM016-011 FRD
 PM016-032 CRD

IRON HANDLEBAR 17,5mm

PM017-001 BK
 PM017-002 WT
 PM017-004 BL
 PM017-011 FRD
 PM017-032 CRD

ALLOY_{C/SLIDER}

Compound for better and more resistant raw material (polypropylene shell). Structure in polished aluminum or painted in black. Applicable to all types of handlebars and easy to install. Two anchorage point.



IRON HANDLEBAR 17,5mm

PM070-001 BK
 PM070-002 WT
 PM070-003 GY
 PM070-004 BL
 PM070-006 YE
 PM070-007 GN
 PM070-009 OR
 PM070-032 CRD

ALUMINUM HANDLEBAR 13,5mm

PM071-001 BK
 PM071-002 WT
 PM071-003 GY
 PM071-004 BL
 PM071-006 YE
 PM071-009 OR
 PM071-011 FRD
 PM071-032 CRD

FAT BAR HANDLEBAR 13,5mm

PM072-001 BK
 PM072-002 WT
 PM072-003 GY
 PM072-004 BL
 PM072-006 YE
 PM072-007 GN
 PM072-009 OR
 PM072-011 FRD
 PM072-032 CRD

ALLOY BICOMP

Totally innovative and modern design. Highly resistant material (polypropylene shell). Structure in polished aluminum or painted in black. Applicable to all types of handlebars and easy to install.



BICOMP SHORT

Totally innovative and modern design. Highly resistant material (polypropylene shell). Structure in polished aluminum or painted in black. Applicable to all types of handlebars and easy to install. Only one anchor point (at the end of the handlebars).



IRON HANDLEBAR 17.5mm

PM040-211	BK/BK
PM040-212	BK/WT
PM040-216	BK/YE
PM040-217	BK/GN
PM040-219	BK/OR
PM040-21A	BK/FRD
PM040-21V	BK/CRD
PM040-224	WT/BL

ALUMINUM HANDLEBAR 13.5mm

PM041-211	BK/BK
PM041-212	BK/WT
PM041-216	BK/YE
PM041-217	BK/GN
PM041-219	BK/OR
PM041-21A	BK/FRD
PM041-21V	BK/CRD
PM041-224	WT/BL

FATBAR HANDLEBAR 13.5mm

PM042-211	BK/BK
PM042-212	BK/WT
PM042-216	BK/YE
PM042-217	BK/GN
PM042-219	BK/OR
PM042-21A	BK/FRD
PM042-21V	BK/CRD
PM042-224	WT/BL

IRON HANDLEBAR 17.5mm

PM048-211	BK/BK
PM048-212	BK/WT
PM048-215	BK/RD
PM048-21A	BK/FRD
PM048-21V	BK/CRD

ALUMINUM HANDLEBAR 13.5mm

PM046-211	BK/BK
PM046-212	BK/WT
PM046-215	BK/RD
PM046-216	BK/YE
PM046-217	BK/GN
PM046-219	BK/OR
PM046-21V	BK/CRD
PM046-224	WT/BL

FATBAR HANDLEBAR 15.88MM

PM047-212	BK/WT
PM047-215	BK/RD
PM047-219	BK/OR
PM047-21A	BK/FRD
PM047-224	WT/BL

ALLOY BICOMP BIG TRAIL

Design and strenght, now for your big trail. Suitable for BMW GS 800.

HANDLEBAR 13.5mm
PM049-211-001
GS 800 FATBAR BK/BK



P4 BICOMPONENTE

High impact resistance.
 Tested under severe conditions. Made of nylon with UV
 protection.
 Applicable to all types of handlebars and easy to install.

IRON HANDLEBAR

PM020-211	BK/BK
PM020-212	BK/WT
PM020-213	BK/GY
PM020-216	BK/YE
PM020-217	BK/GN
PM020-219	BK/OR
PM020-21V	BK/CRD
PM020-221	WT/BK
PM020-224	WT/BL
PM020-22AA	WT/TBL
PM020-22V	WT/CRD

ALUMINUM HANDLEBAR

PM021-211	BK/BK
PM021-212	BK/WT
PM021-213	BK/GY
PM021-216	BK/YE
PM021-217	BK/GN
PM021-219	BK/OR
PM021-21V	BK/CRD
PM021-221	WT/BK
PM021-224	WT/BL
PM021-22AA	WT/TBL
PM021-22V	WT/CRD

FATBAR HANDLEBAR

PM022-211	BK/BK
PM022-212	BK/WT
PM022-213	BK/GY
PM022-216	BK/YE
PM022-217	BK/GN
PM022-219	BK/OR
PM022-21V	BK/CRD
PM022-221	WT/BK
PM022-224	WT/BL
PM022-22AA	WT/TBL
PM022-22V	WT/CRD



SX BICOMPONENTE

Highly resistant material (polypropylene). For light drum brake motorcycles. Protects rider's hands and levers of the bike against stone, mud and dust.

COLORS

PM033-001	BK
PM033-002	WT
PM033-003	GY
PM033-004	BL
PM033-006	YE
PM033-007	GN
PM033-008	OR
PM033-009	FRD
PM033-032	CRD
PM033-043	TBL
PM033-202	DRD/WT
PM033-212	BK/WT
PM033-216	BK/YE
PM033-217	BK/GN
PM033-219	BK/BRD
PM033-21V	BK/CRD
PM033-21U	BK/UMB
PM033-242	BL/WT
PM033-2A2	FRD/WT
PM033-2AA2	TBL/WT
PM033-2V2	CRD/WT



SX

DISC BRAKE

Suitable for Motocross, Rally and Enduro. Highly resistant material (polypropylene shell).

Rod available in high strength nylon or aluminum.

Universal fixing for easy installation.

Protects the rider's hands and motorcycle levers against stone, clay and dust.

DRUM BRAKE

Highly resistant material (polypropylene).

For light drum brake motorcycles.

Protects the rider's hand and motorcycle levers against stone, mud and dust.

DISC BRAKE

COLORS

PM030-001 BK
PM030-002 WT
PM030-003 GY
PM030-004 BL
PM030-006 YE
PM030-009 OR
PM030-011 FRD
PM030-032 CRD
PM030-043 TBL

DRUM BRAKE

COLORS

PM031-001 BK
PM031-003 GY
PM031-004 BL
PM031-006 YE
PM031-008 OR
PM031-009 FRD
PM031-032 CRD
PM031-043 TBL



CLASSIC

Indicated for scooter type motorcycles.
Has classic and perfect design for a comfortable and safe grip.
Has anodized aluminum ring in the Tips with the circuit logo.
For short handle bikes.

COLORS

MA014-124 BK/TI
MA014-21K BK/GD
MA014-34A BN/TI
MA014-34K BN/GD



SILVERSTONE

With anodized rings and unique and modern design.
Flexible plastic region made of soft and comfortable Raw-material already known in the market. Has texture in diamonds with exclusive dimensions for guarantee the grip.
Has a solid aluminum handle fixed with screw stainless.
Has ideal length for all type of motorcycle.

COLORS

MA017-211	BK/BK
MA017-21K	BK/GD
MA017-21M	BK/AL
MA017-231	GY/BK
MA017-23K	GY/GD
MA017-23M	GY/AL
MA017-341	BN/BK
MA017-34K	BN/GD
MA017-34M	BN/AL



BARCELONA

Made with high abrasion resistant material.
It has an anatomical design.
Suitable for YAMAHA YBR, HONDA CG and similar.
DIAMETER: E = 22 MM | D = 24 MM
DIMENSION: 136 MM

COLORS

MA043-001	BK
MA043-002	WT
MA043-003	GY
MA043-004	BL
MA043-005	RD
MA043-006	YE
MA043-029	ORF
MA043-030	GNF
MA043-034	BN
MA043-037	FPK



REVOLUTION

Made with high abrasion resistant material. Resistance to weathering and chemical reagents.

Designed for street bikes.

DIAMETER: E = 22 MM | D = 26 MM

DIMENSION: 117 MM

COLORS

MA033-001 BK
MA033-005 RD



REVOLUTION II

Made with high abrasion resistant material. Resistance to weathering and chemical reagents.

Designed for street bikes.

DIAMETER: E = 22 MM | D = 26 MM

DIMENSION: 117 MM

COLORS

MA034-001 BK
MA034-005 RD



SPEED EVERYDAY

Made with high abrasion resistant material.
Indicated for street motorcycles,
being compatible for all sport bikes.
DIAMETER: E = 22 MM I D = 24 MM
DIMENSION: 122 MM

CLOSED TIP

MA054-212 BK/WT
MA054-213 BK/GY
MA054-214 BK/BL
MA054-215 BK/RD
MA054-216 BK/YE
MA054-217 BK/GN
MA054-231 GY/BK

OPENED TIP

MA055-213 BK/GY
MA055-214 BK/BL
MA055-215 BK/RD



RACING

Made with italian rubber (high grip material).
Designed for motorcycles.
Tested and approved by
moto gp riders.
DIAMETER: E = 22 MM I D = 24 MM
DIMENSION: 122 MM

CLOSED TIP

MA051-212 BK/WT
MA051-213 BK/GY
MA051-214 BK/BL
MA051-215 BK/RD
MA051-216 BK/YE
MA051-219 BK/OR

OPENED TIP

MA053-212 BK/WT



CAFFÈ

Made with soft and resistant material.

Especially indicated for:

HONDA BROS, XRE, YAMAHA CROSSER and similar.

DIAMETER: E = 22 MM | D = 24 MM

DIMENSION: 112 MM

COLORS

MA045-001	BK
MA045-003	GY
MA045-004	BL
MA045-005	RD
MA045-006	YE
MA045-034	BN



INTERLAGOS PLUS

Made with high abrasion resistant material.
Design provides softness and comfort.
Suitable for HONDA CG, YAMAHA YBR
and similar. In two versions:
closed and opened.

DIAMETER: E = 22 MM I D = 24 MM
DIMENSION: 136 MM

CLOSED

MA037-001 BK
MA037-002 WT
MA037-003 GY
MA037-004 BL
MA037-005 RD
MA037-006 YE
MA037-029 ORF
MA037-030 GNF
MA037-034 BN
MA037-037 FPK
MA037-043 TBL

OPENED

MA041-001 BK



INTERLAGOS PLUS C/TUBO

Made with high abrasion resistant material.
Design provides softness and comfort.
Suitable for CG 125/150 (models up to 2013).

DIAMETER: E = 22 MM I D = 24 MM
DIMENSION: 136 MM

COLORS

MA049-001 BK
MA049-003 GY
MA049-004 BL
MA049-005 RD
MA049-006 YE
MA049-037 FPK



INTERLAGOS

Made with high quality pvc.
Weather and chemical resistant.
Anodized aluminum rings.
Elegant and modern look.
Designed for street bikes.
DIAMETER: E = 22 MM I D = 24 MM
DIMENSION: 128 MM

COLORS

MA048-001 BK
MA048-003 GY
MA048-004 BL
MA048-005 RD
MA048-006 YE
MA048-022 PK
MA048-037 FPK
MA048-043 TBL



INTERLAGOS

BICOMP II

Made with high abrasion resistant material
Keeping the softness that a gauntlet should
Have. It has an anatomical design.
Suitable for HONDA CG, YAMAHA YBR and similar.
DIAMETER: E = 22 MM | D = 24 MM
DIMENSION: 136 MM

COLORS
MA050-214 BK/BL
MA050-215 BK/RD
MA050-216 BK/YE
MA050-21Y BK/FPK
MA050-2C1 GY/BK



STORM

Made with high quality pvc.
Weather and chemical resistant.
Anodized aluminum rings.
Elegant and modern look.
Designed for street bikes.
DIAMETER: E = 22 MM I D = 24 MM
DIMENSION: 138 MM

COLORS

MA047-211	BK/BK
MA047-214	BK/BL
MA047-215	BK/RD
MA047-21K	BK/GD
MA047-21M	BK/AL
MA047-231	GY/BK
MA047-23M	GY/AL



SUPER SOFT

Comfortable and highly durable handle.

COLORS

MA031-001 BK

MA031-003 GY

MA031-004 BL

MA031-005 RD



ELECTRA EVERYDAY

Available in the everyday version, for in Love with the off-road that like bring Culture to the streets.
This version is made of high resistance Material weather and abrasion.

COLORS

MA009-212 BK/WT
MA009-213 BK/GY
MA009-215 BK/RD
MA009-216 BK/YE
MA009-217 BK/GN
MA009-219 BK/OR
MA009-21Y BK/PK
MA009-21Z BK/FBL
MA009-242 BL/WT
MA009-252 RD/WT



JUPITER RACING

Produced with Italian rubber
(high grip material).
Suitable for competition motorcycles.
DIAMETER: E = 22 MM | D = 24 MM
DIMENSION: 117 MM

COLORS	RACING
MA042-212	BK/WT
MA042-213	BK/GY
MA042-215	BK/RD
MA042-216	BK/YE
MA042-217	BK/GN
MA042-219	BK/OR
MA042-21Y	BK/FPK
MA042-21Z	BK/FBL
MA042-242	BL/WT
MA042-252	RD/WT
MA042-276	GN/YE



RACING II

Produced with Italian rubber
(high grip material).
Suitable for competition motorcycles.
Opened tip to fit the handguard.
DIAMETER: E = 22 MM | D = 24 MM
DIMENSION: 117 MM

COLORS	RACING II
MA057-215	BK/RD



EVERYDAY

Produced in specific material for
Use in street motorcycles.
DIAMETER: E = 22 MM | D = 24 MM
DIMENSION: 117 MM

COLORS	EVERYDAY
MA056-212	BK/WT
MA056-213	BK/GY
MA056-215	BK/RD
MA056-216	BK/YE
MA056-217	BK/GN
MA056-219	BK/OR
MA056-21Y	BK/FPK
MA056-21Z	BK/FBL
MA056-242	BL/WT
MA056-252	RD/WT
MA056-256	RD/YE



CARBON 250

Finish that simulates carbon fiber.

Indicated for:

Yamaha TÉNÉRÉ 250, Yamaha LANDER 250,
Yamaha CROSSER 150, Honda XRE 300, Honda CRF 230.

The carbon 250 line comes with everything in the kit.



INSTALLATION KIT

CD003-001 CAR XRE300 / CRF250

CD004-001 CAR TÉNÉRÉ 250 / LANDER 250 / CROSSER 250

CD006-001 CAR CRF 230



BROS_{150/160}

Finish that simulates carbon fiber.
Suitable for honda BROS 150/160 e XRE 190.

COLORS

CD005-212	CARBON	BK/WT
CD005-213	CARBON	BK/GY
CD005-21A	CARBON	BK/FRD
CD005-21R	CARBON	BK/FYE
CD005-21S	CARBON	BK/FOR
CD005-21W	CARBON	BK/PGN
CD005-21Z	CARBON	BK/FBL

XRE₁₉₀



CIRCUIT II

Made from high-resistance polypropylene, this protector features strategically positioned air inlets to optimize brake disc cooling. Developed to offer maximum protection, it protects not only the disc, but also the motorcycle caliper, prolonging the useful life of these essential components. Designed specifically for Honda Tornado models, this protector is a reliable addition to ensure your motorcycle's performance and durability in hard conditions.

COLORS
CD002-007 GN
CD002-032 CRD



TRACKER

With an exclusive italian design, made of thermoplastic (Highly resistance) and a carbon fiber finishing modern look. Designed especially for models HONDA CG 150/160 from 2014.

INSTALLATION KIT
PF017-001 TRACKER CARBON BK



DRAGON

Carbon look.
Highly resistant material.
Protection allied with modern design.
Designed for CG line 150 until 2008.

INSTALLATION KIT
PF013-211 CARBON



POP

With an exclusive italian design,
made ofthermoplastic (highly resistance)
and a carbon fiber finishing modern look.
Designed especially for POP 100/110 models.

INSTALLATION KIT
PF018-001 POP CARBON BK



STEALTH

Designed especially for supermoto.
Highly resistant material (polypropylene).
Made of two injected parts
once coupled are
an original piece with
modern design.

COLORS

PF004-001	SM BK
PF004-002	SM WT
PF004-003	SM GY
PF004-004	SM BL
PF004-006	SM YE
PF004-007	SM GN
PF004-009	SM OR
PF004-011	SM FRD
PF004-032	SM CRD
PF004-035	SM CRD
PF004-222	SM WT/WT
PF004-224	SM WT/BL
PF004-226	SM WT/YE
PF004-227	SM WT/GN
PF004-229	SM GY
PF004-22A	SM BL
PF004-22V	SM YE



BAGUS

Easy installation number plate in matte Polycarbonate.
 Made with polypropylene.
 Optical globe with polycarbonate lens, philips Lamp 12v of 2x3 5w filament.
 Rubber belts set to allow setting in different Diameter sticks. Ce and dot certificate.

COLORS

HL020-211	BK/BK
HL020-212	BK/WT
HL020-221	WT/BK
HL020-222	WT/WT
HL020-242	BL/WT
HL020-252	RD/WT
HL020-262	YE/WT
HL020-272	GN/WT
HL020-292	OR/WT
HL020-2A2	FRD/WT



POLICARBONATO TRANSLUCENT

COLORS

HL021-21E	BK/SM
HL021-22E	WT/SM



MANTIS

Highly resistant material (polypropylene).
Led available with crystal or red lens.
Includes bolt kit for universal fixing and
Marking for assembly.

COLORS

PT003-215	BK/RD
PT003-211	BK/WT
PT003-225	WT/RD
PT003-221	WT/CR



RAPTOR

Highly resistant material (polypropylene).
With red lens, two poles philips lamp.
Includes bolt kit for universal fixing.

COLORS

PT002-098	PORTA
PLACA	RAPTOR NEN



TURN SIGNAL LIGHT

Exclusive, bold, compact and universal application.
Base made of flexible and highly impact resistant
Rubber. Integrated by a lens made of polycarbonate and
High power lamp.

COLORS
HL010-001 OR



TURN SIGNAL LED

Exclusive, bold, compact and universal application.
Base made of flexible and highly impact resistant
Rubber. Integrated by a board made up of 15 high-life leds.
Crystal color lens.

COLORS
HL011-001 CRISTAL



CIRCUIT 2017

Curvature adapted so as not to
Damage the fairing when using the Hand guard.
Dimension: 73 cm

COLORS
AC022-001 BK



HANDLEBAR

CIRCUIT
RACING EQUIPMENT

COMBOS

- 01 handlebars
- 01 pair of street hand protectors
- 01 pair of speed grips
- 01 mxiii handlebar protector



L.11

Tested and approved by
The best Brazilians pilots.
Indicated for fat bar type handlebars.

COLORS

HP011-EQP-WT	WT
HP011-EQP-BK	BK
HP011-EQP-VMF	VMF



CIRCUIT L.9

Made of polyurethane
Dimension: 245 mm

COLORS

HP004-009	OR
HP004-21R	BK/RDF
HP004-22AA	BK/BLTM
HP004-EQP-BC	EQP WH
HP004-EQP-PT	EQP BK
HP004-EQP-VMF	EQP YEF
HP004-VDE	GNF



MX3

Made in foam
and covered by vinyl.
Dimension: 230 mm

COLORS

HP016-215
HP016-216
HP016-217
HP016-219
HP016-21R
HP016-22AA
HP016-241



BAR KIT PROTECTION

Specially developed for HONDA BROS.
Composed by:
01 handlebar bar (made of solid aluminum)
01 handlebar protector (made of foam)
01 vinyl cover covering

COLORS

ZZ006-001 WT



FLAME

Made of high grip and comfort material.
Machined aluminum tip and canopy.
Accompanying tube accelerator produced in the
Options of long and short handle.
Designed for Harley Davidson motorcycles.

LONG
MA028-001 BK
SHORT
MA029-001 BK



CUSTOM

Made from high quality, flexible pvc.
High durability, resistance against sweat,
gasoline, alcohol, lubricants and others.
Suitable for street, touring, road and motorcycle
Bikes. Textured finish and smooth chrome tips or
with encrusted eagle insignia.

TRADITIONAL TIP

DIAMETER: E = 22 MM | D = 24 MM
DIMENSION: 135 MM

MA026-001 BK
MA026-013 SL
MA026-034

EAGLE TIP

DIAMETER: E = 22 MM | D = 24 MM
DIMENSION: 135 MM

MA027-001 BK
MA027-013 SL

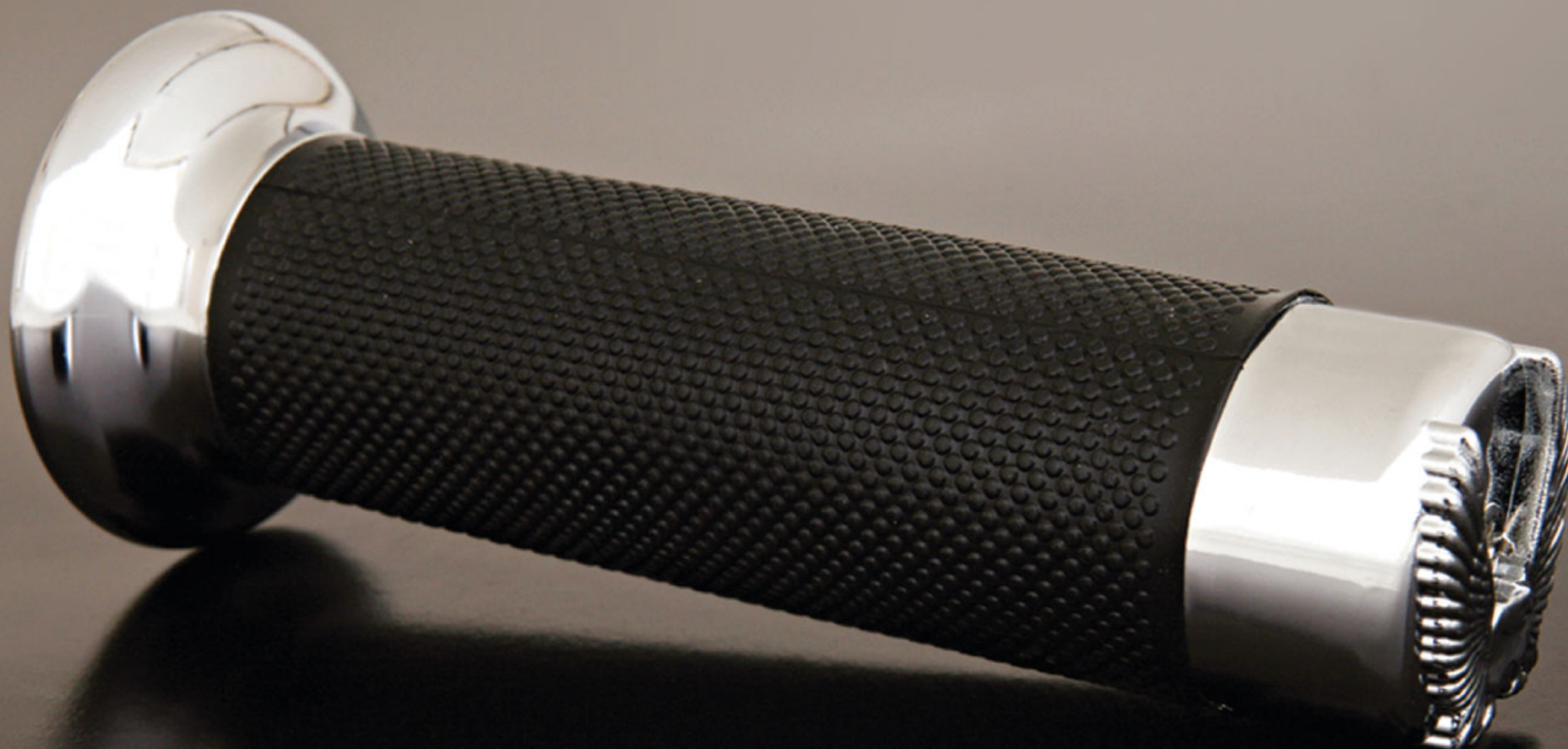

ROCKET

Made from high quality, flexible pvc.
High durability, resistance against sweat,
gasoline, alcohol, lubricants and others.
Suitable for street, touring, road and motorcycle
Bikes. And in the JR version suitable for BIS, YAMAHA
CRIBKON and scooter type motorcycles.
DIAMETER: E = 22 MM | D = 24 MM
DIMENSION: 150 MM

COLORS
MA022-001 BK

ROCKET JR

DIAMETER: E = 22 MM | D = 24 MM
DIMENSION: 128 MM

COLORS
MA021-001 BK



FORK BOOTS

Protects the motorcycle fork against dust, mud and stones, prolonging its useful life. Produced with resistant and durable material (Flexible pvc).



10 FOLDS

Suitable for Honda POP 100.

COLORS

SS006-001 BK
 SS006-004 BL
 SS006-005 RD
 SS006-006 YE

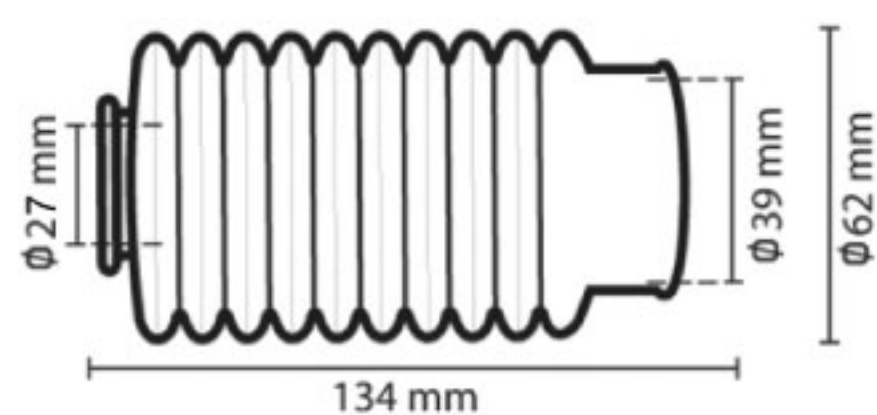

11 FOLDS

Suitable for: Honda TWISTER, Honda STRADA, Honda TITAN, Yamaha RD135, Yamaha YBR, Factor 125, Fazer 250, Honda CG 125, Fan 125, Cargo, CB 300.

COLORS

SS001-001 BK
 SS001-003 GY
 SS001-004 BL
 SS001-005 RD
 SS001-006 YE
 SS001-016 TGN
 SS001-029 FOR
 SS001-030 FGN

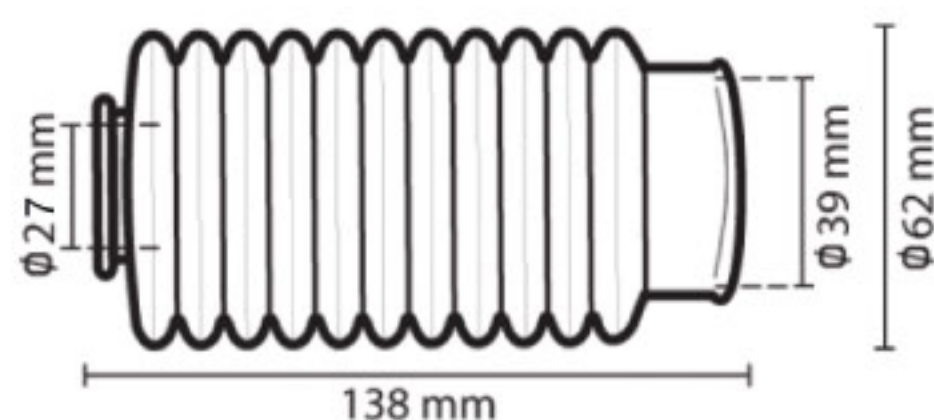

13 FOLDS

Suitable for: Honda TWISTER, Honda STRADA, Honda TITAN, Yamaha RD135, Yamaha YBR, Factor 125, Fazer 250, Honda CG125, Fan 125, Cargo, CB 300.

COLORS
 SS007-001 BK
 SS007-004 BL
 SS007-005 RD
 SS007-006 YE

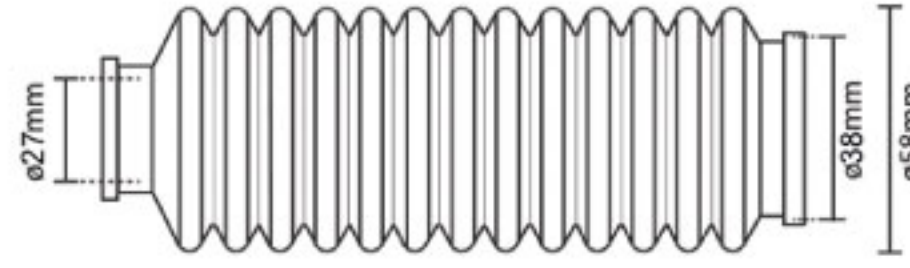

ADAPTERS



COLORS
 SS10-001 2009 - 2014
 SS10-004 2009 - 2014
 SS10-005 2009 - 2014



COLORS
 SS12-001 UNIVERSAL CG 125
 SS12-004 UNIVERSAL CG 125
 SS12-005 UNIVERSAL CG 125



COLORS
 SS13-001 UNIVERSAL CG 150/160
 SS13-004 UNIVERSAL CG 150/160
 SS13-005 UNIVERSAL CG 150/160

18 FOLDS

Suitable for CROSSER 150, BROS 125 e XTZ 125.

COLORS
 SS002-001 BK
 SS002-003 GY
 SS002-004 BL
 SS002-005 RD
 SS002-006 YE
 SS002-029 FOR
 SS002-030 FGN

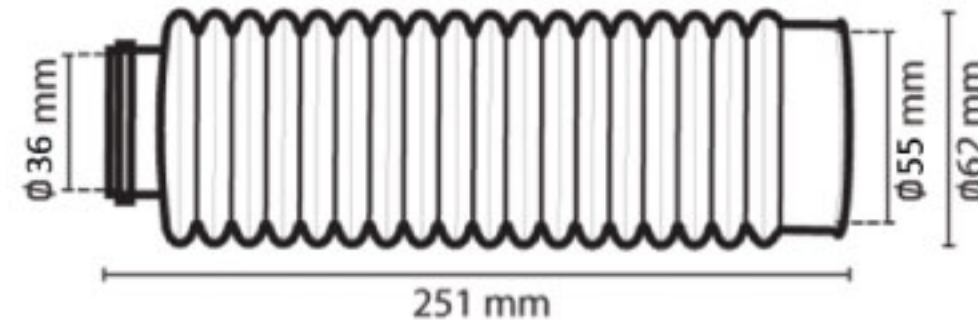

21 FOLDS

Suitable for: BROS 150 a partir de 2009, BROS 160 e XRE 190.

COLORS
 SS009-001 BK
 SS009-003 GY
 SS009-004 BL
 SS009-005 RD
 SS009-006 YE
 SS009-029 FOR
 SS009-030 FGN

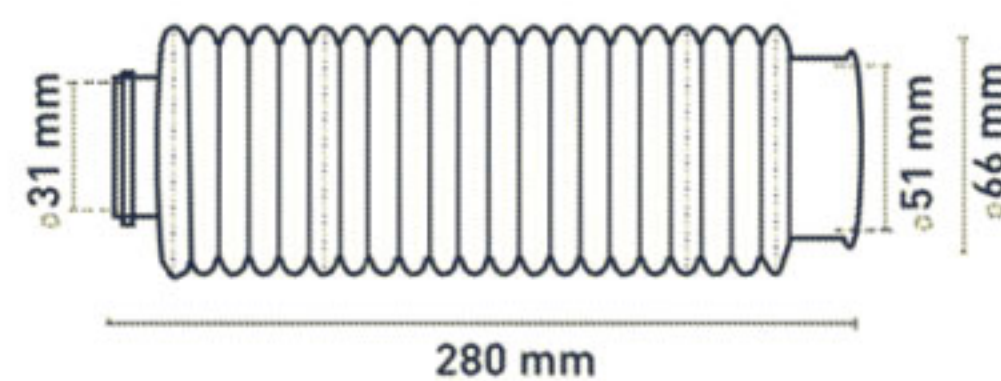

24 FOLDS

Suitable for:
Honda CRF 230, TTR 230, XLX 350,
DT 200, NX 200, XR 200, XL 250,
SAHARA 350, TORNADO,
TDM, SUNDOWN STX, TÉNÉRÉ 250
e LANDER 250.

COLORS
SS003-001 BK
SS003-003 GY
SS003-004 BL
SS003-005 RD
SS003-006 YE
SS003-029 FOR
SS003-030 FGN

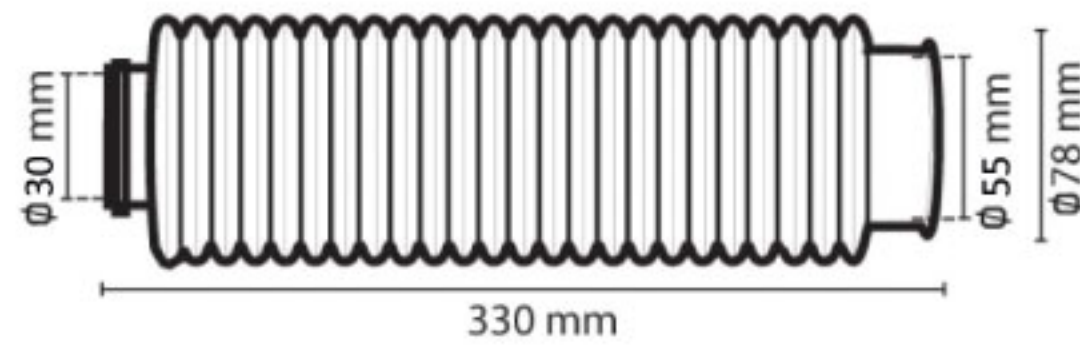

32 FOLDS

Suitable for: XR 250/400/600/650,
DR 350/650/800, KLX 250/400 e
XT 600/660, TENERÉ 250/600/660.

COLORS
SS004-001 BK
SS004-004 BL
SS004-005 RD
SS004-006 YE
SS004-029 FOR
SS004-030 FGN

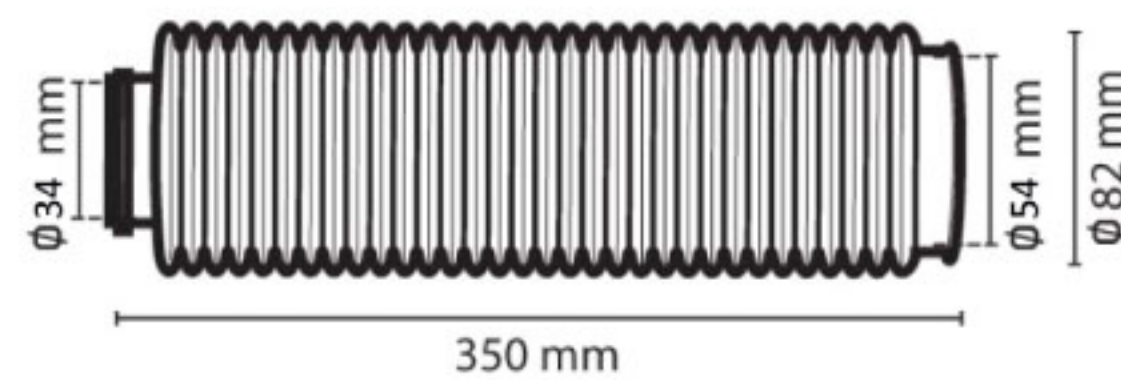

32 FOLDS XL

Suitable for:
XR 400/600/650, DR 350/650/800,
KLX 250/400, XT 600/660,
XTZ 750, TENERÉ 600/660

COLORS
SS005-001 BK
SS005-003 GY
SS005-004 BL
SS005-005 RD
SS005-006 YE
SS005-029 FOR
SS005-030 FGN

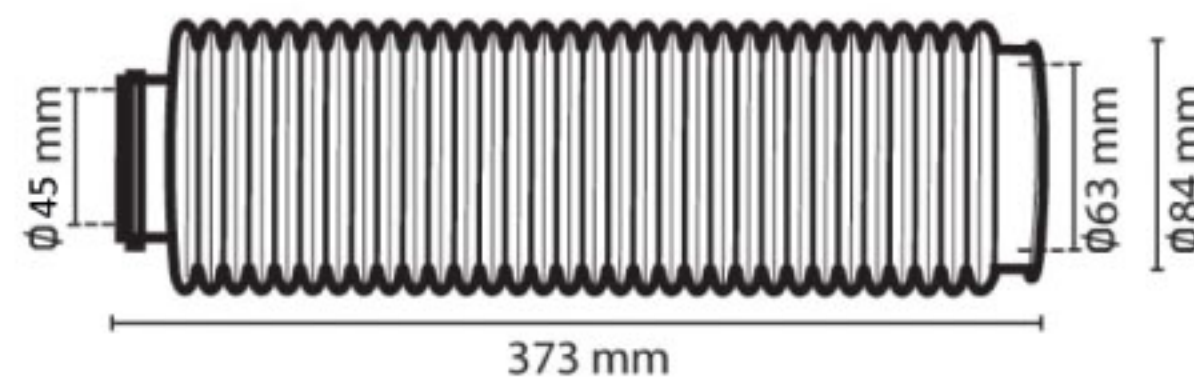

3 FOLDS

Protege a bengala da moto contra
poeira, barro e pedras, prolongando sua vida útil.
Produzida com material resistente e
durável (PVC flexível).
Indicada para motos:
Harley Davidson Modelo IRON 883.

CORES
SS011-001 PT

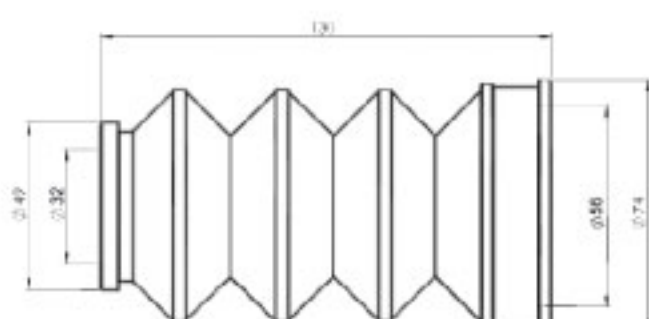

SMART 28 MATCH

Italian design with capacity of 28 liters.
Exclusive locking system with password and
Aluminum rack.
Fixing system that does not generate vibration.
Available in two fixing obkions developed by
Circuit: one with an exclusive fixing system
most suitable for tubular racks.

COLORS

BA007-001 CASE CIRCUIT SMART MATCH 28L LF - BLACK
BA007-024 CASE CIRCUIT SMART MATCH 28L LF - TITANIUM
BA008-001 CASE CIRCUIT SMART MATCH 28L SF - BLACK
BA007-024 CASE CIRCUIT SMART MATCH 28L SF - TITANIUM



SCOOTER PLATE

Plate kit for mounting the Smart 28 top case on a scooter.
Custom sale.

COLORS
BA003-098

MODELS
HONDA SH 125-150-300CC
HONDA XADV 750CC
PIAGGIO BEVERLY 300-350CC
PIAGGIO LIBERTY 50-125-150CC
KYMCO AGILITY 50-125-150-200CC
YAMAHA XMAX 125-300-400CC
YAMAHA TMAX
YAMAHA TRICITY



CHAIN PROTECTOR CG 125/150

Developed for the entire range of HONDA CG 125/150 models until 2014.

Made of high strength polypropylene.

It has opening for oil application in the chain.

Extends the life of the motorcycle's secondary Ratio.

Easy installation.

Comes with mounting kit.

CG 150

CC002-001 BK

CC002-003 GY

CC002-013 PR

CG 125

CC001-001 BK



FRAME PROTECTOR TORNADO

Especially suitable for HONDA TORNADO.

Produced in polypropylene. Easy installation.

Protects the motorcycle chassis against stones and dirt.

COLORS

FG001-001 PROT CHASSI

TORNADO BK



ALUMINUM ROD KIT VECTOR

Spare aluminum rods Vector hand guard. Available in colors or pure aluminum.

COLORS

RP027-001 KIT HASTE AL VECTOR BK
 RP027-004 KIT HASTE AL VECTOR BL
 RP027-021 KIT HASTE AL VECTOR GD
 RP027-098 KIT HASTE AL VECTOR AL

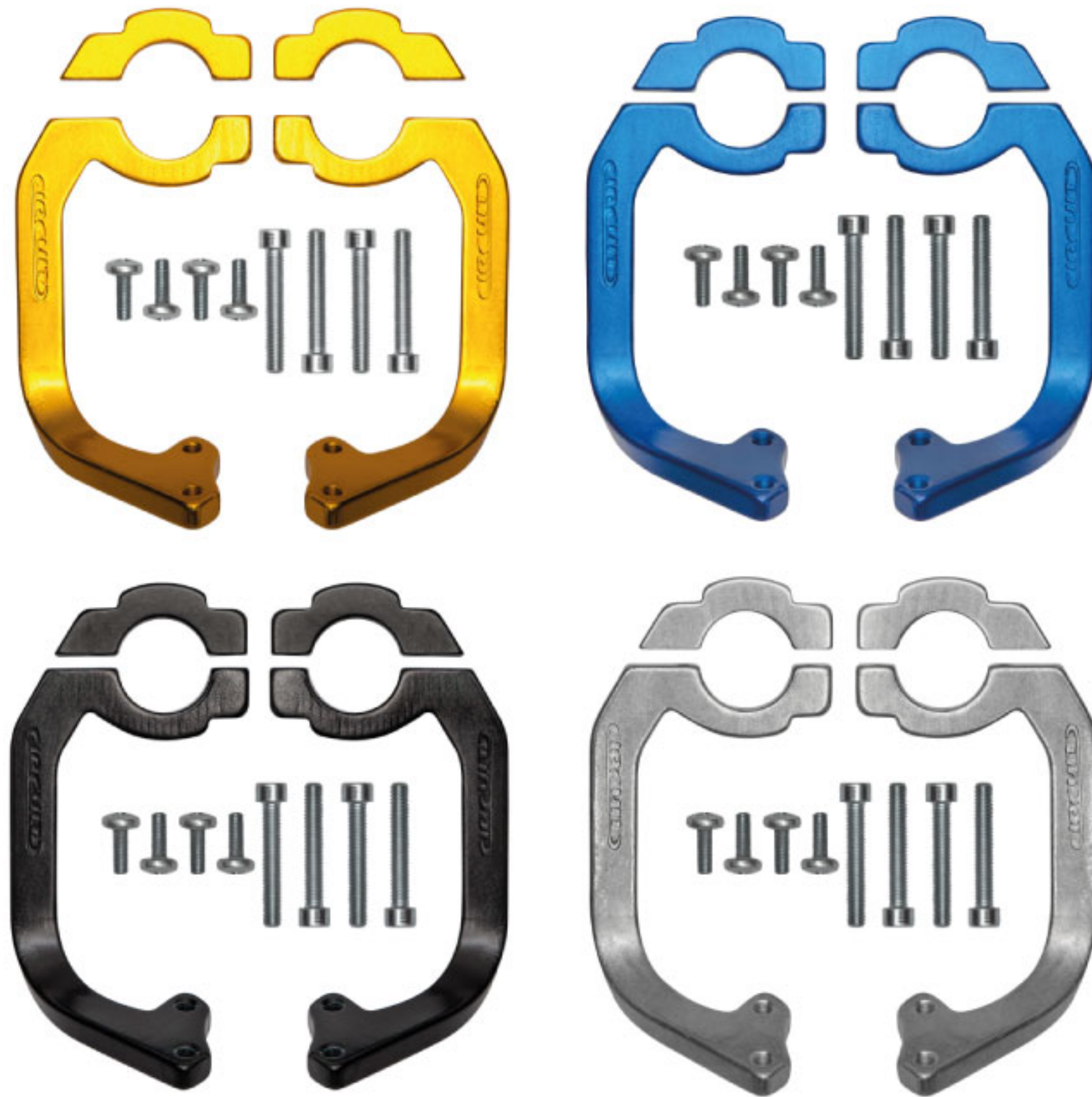

PLASTIC ROD KIT VECTOR

Plastic rods made of nylon. Indicated for handguards Vector and SX bicomponent.

CODE
 RP029-001 KIT HASTE VEC SX BK



ROD 9

CODE
 RP070-098 KIT HASTE 9 CIRCUIT 28MM
 RP071-098 KIT HASTE 9 CIRCUIT 32MM



BRACKETS 28MM

Suitable for fhs, alloy, p4 and fênix hand protectors. Clamp kit compatible with all models conical handlebar with 28.6 mm external diameter.

CODE
 RP021-098 KIT BRACKETS CIRCUIT 28MM
 RP003-098 KIT BRACKETS FHS PRO TAPER



ALMA BRACKETS

Split clamps.
Indicated for iron and aluminum handlebar.
Produced in polished aluminum.

CODE
RP002-098 KIT BRACKETS ALMA



ADAPTERS

Suitable for hand protectors in alma and alloy models. Produced in polished aluminum.

CODE
RP009-098 KIT ADAPTERS CIRCUIT ALMA/ALLOY



ADAPTERS P4

Installation kit for p4 hand guard aluminum handlebar.

CODE
RP008-098 KIT ADAP AL BK NEN



SLIDER

Indicated to protect and prolong the useful life of the metal core of the hand protectors in the alloy and alloy short models. Prevents possible scratches on the aluminum core. Produced in polypropylene.

ALLOY E ALLOY SHORT
RP031-001 BK



COVER GRIP

Resistant to abrasion and indicated to give aesthetic finishing to the grip. Made of abs material. Made of vinyl. Protects the handle surface against oil, grease and dirt during mechanical maintenance of the motorcycle.

COLORS
AM002-098 PROT MANOPLA NEN
AM002-FCB PROT MANOPLA GRIPS FCB
AM002-001 PROT MANOPLA GRIPS BK



LENS CIRCUIT RAPTOR

Replacement part for the raptor circuit board holder. Made of polycarbonate and available only in amber color.

COLORS
PT002-098 LENS PC W/ PLATE HOLDER RAPTOR NEN



BAG CIRCUIT

Multi-accessories bag in polyester with logo printed by Silk screen.

COLORS

- BK003-001 BLACK
- BK003-005 BLACK/OR



BIKE



FLASH

Produced in resistant material. It has a texture that allows the flow of sweat or rainwater.
Suitable for MTB, BMX and touring.

DIAMETER: E = 22 MM | D = 22 MM DIMENSION: 134 MM

COLORS

MA090-001	BK
MA090-002	WT
MA090-003	GY
MA090-004	BL
MA090-005	RD
MA090-006	YE
MA090-028	FYE
MA090-034	BN
MA090-037	FPK



ADVENTURE

Produced in gel rubber (high adhesion material).
Tip made of highly resistant material.
Developed to ensure the best grip and softness.
Suitable for MTB, BMX and touring.
DIAMETER: E = 22 MM I D = 22 MM
DIMENSION: 134 MM

COLORS
MA083-001 BK
MA083-003 GY
MA083-004 BL
MA083-005 RD



TITANIUM

Produced in gel rubber (high adhesion material).
Exclusively designed for bmx bikes.
Also suitable for bicross, freestyle and Touring.
DIAMETER: E = 22 MM I D = 22 MM
DIMENSION: 144 MM

COLORS

MA082-001	BK
MA082-003	GY
MA082-004	BL
MA082-005	RD
MA082-006	YE
MA082-008	PU

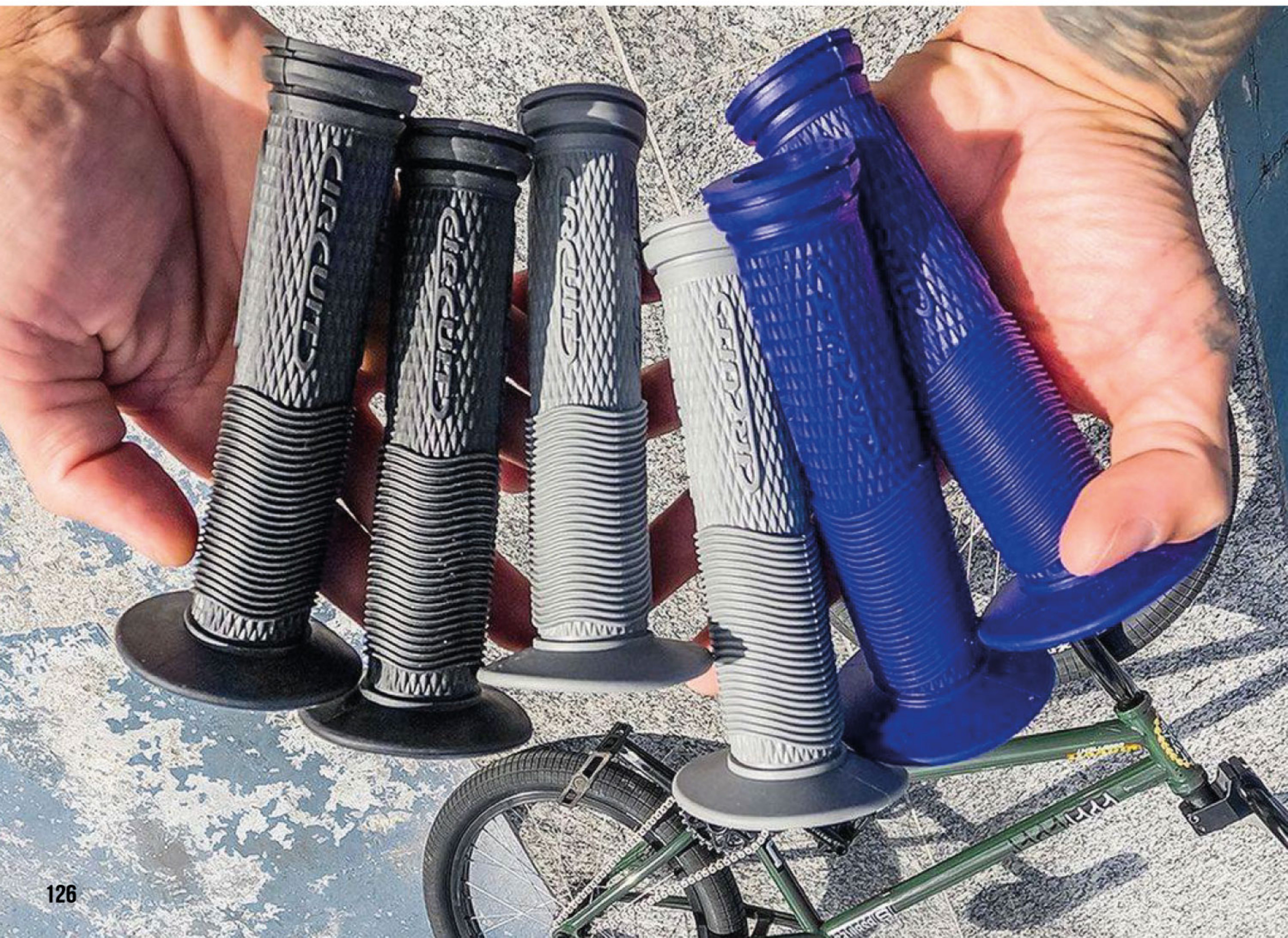

HEXAGON

Inner tube made of rigid material ensuring grip on the Handlebars. Durable and soft outer material. It has resistant tips and clamps that fix to the handlebars According to the grip. Supplied with screws and allen key kit. Suitable for MTB. And touring.
 DIAMETER: E = 22 MM I D = 22 MM
 DIMENSION: 134 MM

COLORS

MA087-211	BK/BK
MA087-212	BK/WT
MA087-214	BK/BL
MA087-215	BK/RD
MA087-21P	BK/GNE
MA087-234	GY/BL



HEXAGON 25

Version with external material produced in gel rubber.
 DIAMETER: E = 22 MM I D = 22 MM
 DIMENSION: 134 MM

COLORS

MA089-211	BK/BK
MA089-212	BK/WT
MA089-214	BK/BL
MA089-215	BK/RD
MA089-21P	BK/GNE
MA089-231	GY/BK
MA089-234	GY/BL



STRADA II

High durability material.
Simple design and good grip.
Suitable for street and touring bikes.
DIAMETER: E = 22 MM I D = 22 MM
DIMENSION: 134 MM

COLORS
MA079-001 BK
MA079-003 GY
MA079-004 BL
MA079-005 RD



REVOLUTION II

BIKE

Made of durable and soft material.
Suitable for street and touring bikes.
DIAMETER: E = 22 MM I D = 22 MM
DIMENSION: 134 MM

COLORS
MA076-001 BK
MA076-005 RD



SPEED BIKE

Made with high abrasion resistant material.

Only available with closed tip.

Suitable for street and touring bikes.

DIAMETER: E = 22 MM | D = 24 MM

DIMENSION: 134 MM

COLORS

MA092-212	BK/WT
MA092-213	BK/GY
MA092-214	BK/BL
MA092-215	BK/RD
MA092-216	BK/YE
MA092-217	BK/GN
MA092-231	GY/BK
MA092-242	BL/WT
MA092-252	RD/WT



INTERLAGOS

BIKE

Made with high quality PVC.
Tip made of highly resistant material.
Developed to guarantee the best grip and softness.
Indicated for MTB, BMX and walking.
DIAMETER: E = 22 MM I D = 22 MM
DIMENSION: 134 MM

COLORS

MA076-001 BK
MA076-005 RD



SUPER SOFT BIKE

Produzida para dar conforto, segurança e ótimo grip. Garante ao ciclista mais maciez e firmeza na pegada. APLICAÇÃO: Nikes MTB, BMX e passeio.
DIMENSÃO: 135MM

COLORS

MA081-001	BK
MA081-003	GY
MA081-004	BL
MA081-005	RD
MA081-006	YE



JERSEY MTB

Long-sleeved shirt in breathable, stretch and slim-fit fabric.

Customizable shirt.

Sizes: S-M-L-XL-XXL

CUSTOM SALES

CODE

TS134-213

SHORT MTB

Fully-stretch, water-repellent shorts with no inner lining, double-adjustment at the outer waistband, front button fastening, and two side pockets.

Sizes: S-M-L-XL

CUSTOM SALES

CODE

TS135-213



VECTOR CARBON

Suitable for MTB bike. Highly resistant material (polypropylene shell), aesthetic finish that simulates carbon fiber. Rod available in high strength nylon, aluminum or anodized aluminum. Universal fixing for easy installation. Protects the rider's hand and motorcycle levers against stone, mud and dust.



NYLON ROD

PM061-2D1	CAR/BK
PM061-2D2	CAR/WT
PM061-2D3	CAR/GY
PM061-2D4	CAR/BL
PM061-2D6	CAR/YE
PM061-2D7	CAR/GN
PM061-2D9	CAR/OR
PM061-2DA	CAR/FRD
PM061-2DAA	CAR/TBL
PM061-2DY	CAR/FPK
PM061-2DR	CAR/FOR
PM061-2DS	CAR/FYE



RACKBIKE

Can be used for bicycle, board, skateboard, etc.
Produced in lightweight and high-resistance
Material (nylon with uv protection).
Structural aluminum tube and polyurethane
Coating tube.
It has a padded backrest to protect the equipment.
Screw kit included for installation.

COLORS

RB001-001 BK
RB001-002 WT
RB001-003 GY



CASUAL



HEAVY JACKET

LIMITED EDITION

The heavy limited edition jacket is just so you don't get cold. It has an internal lining ensuring heat conservation even at low temperatures. It has an adjustable belt, collar with retractable hood.

COLORS
JK007-001-M BK



RAIN JACKET

CROSS WIND

Made of transparent material that allows see the indication of sponsorships.
Printed on the uniform under it.
Has side slots for continuous body ventilation.
Cuffs and collar made of elastic material for best body fitness.

SIZES
TS102-019-L
TS102-019-M
TS102-019-S
TS102-019-XL
TS102-019-XXL



T-SHIRT

CIRCUIT EQUIPMENT

Made of 100% cotton and only available with short sleeves.

CASUAL LINE



BLACK
TS041-001-S
TS041-001-M
TS041-001-L
TS041-001-XL

WHITE
TS041-002-S
TS041-002-M
TS041-002-L



TRUCKER CAP

CIRCUIT EQUIPMENT

Perfect choice for those looking for style and comfort.
Made in polyester.

COLORS

CT011-001	BK/WT
CT011-004	BL/WT
CT011-005	RD/WT
CT011-007	GN/WT
CT011-022	PK/WT
CT011-034	BN/WT
CT011-211	BK/BK
CT011-245	BL/RD/WT
CT011-CM	CM



MECHANIC GEAR

Pants and shorts suitable for use in the field and in the workshop.
Available sizes: from M to XXL

CUSTOM SALE.

PANTS
TS104-001

SHORTS
TS103-001



CASUAL LINE

CIRCUIT
RACING EQUIPMENT



SCAN
ME 

COLORS

001 BLACK	
002 WHITE	
003 GREY	
004 BLUE	
005 RED	
006 YELLOW	
007 GREEN	
008 PURPLE	
009 ORANGE	
011 RED FLUO	
022 PINK/WHITE	
023 ALUMINUM	
024 TITANIUM	
025 GOLD	
028 YELLOW FLUO	
029 ORANGE FLUO	
030 GREEN FLUO	
032 RED CIRCUIT	
034 BROWN	
035 GREEN PISTACHIO	
037 PINK FLUO	
039 BLUE FLUO	
043 BLUE TM	

211 BLACK/BLACK	
212 BLACK/WHITE	
213 BLACK/GREY	
214 BLACK/BLUE	
215 BLACK/RED	
216 BLACK/YELLOW	
217 BLACK/GREEN	
219 BLACK/ORANGE	
21I BLACK/CRYSTAL	
21K BLACK/GOLD	
21M BLACK/ALLUMINUM	
21P BLACK/GREEN ARMY	
21U BLACK/RED B	
21V BLACK/RED CIRCUIT	
21Y BLACK/PINK FLUO	
21Z BLACK/BLUE FLUO	
221 WHITE/BLACK	
222 WHITE/WHITE	
224 WHITE/BLUE	
225 WHITE/RED	
229 WHITE/ORANGE	
22AA WHITE/BLUE TM	
22A WHITE/RED FLUO	
22I WHITE/CRYSTAL	
22R WHITE/YELLOW FLUO	
22V WHITE/RED CIRCUIT	
231 GREY/BLACK	
234 GREY/BLUE	
23M GREY/ALLUMINUM	
242 BLUE/WHITE	
245 BLUE/RED/WHITE	
252 RED/WHITE	
261 YELLOW/BLACK	

262 YELLOW/WHITE	
256 RED/YELLOW	
267 YELLOW/GREEN	
271 GREEN/BLACK	
272 GREEN/WHITE	
276 GREEN/YELLOW	
291 ORANGE/BLACK	
292 ORANGE/WHITE	
2A2 FLUO RED/WHITE	
2V2 CIRCUIT RED/WHITE	
2W1 BLACK/PISTACHIO GREEN	
AA2 BLUE TM/WHITE	
21E BLACK/SMOKE	
22E WHITE/SMOKE	

2D1 CARBON/BLACK	
2D2 CARBON/WHITE	
2D3 CARBON/GREY	
2D4 CARBON/BLUE	
2D5 CARBON/RED	
2D6 CARBON/YELLOW	
2D7 CARBON/GREEN	
2D8 CARBON/PURPLE	
2D9 CARBON/ORANGE	
2DA CARBON/FLUO RED	
2DR CARBON/FLUO YELLOW	
2DS CARBON/FLUO ORANGE	
2DY CARBON/FLUO PINK	
2DAA CARBON/BLUE TM	

805 BLUE	
806 RED	
811 WHITE	
812 BLACK	

H01 BLACK/BLACK	
H02 GRAY 09/BLACK	
H03 BLUE 08-09/BLACK	
H04 RED 09/BLACK	
H05 BLUE 07/BLACK	
H06 RED 07-08/BLACK	
H07 YELLOW 07-08/BLACK	
H08 WHITE 10/BLACK	
H09 ORANGE 10/BLACK	
H20 PURPLE 11/BLACK	

H11 GRAY 09	
H12 BLUE 08-09	
H13 RED 09	
H14 BLUE 07	
H15 RED 07-08	
H16 YELLOW 07-08	
H17 WHITE 10	
H18 ORANGE 10	
H19 PURPLE 11	

CM CAMOUFLAGE	
----------------------	--



CIRCUIT EQUIPAMENTOS ESPORTIVOS LTDA

Av. Alexandrina das Chagas Moreira, 760
Pindamonhangaba - Distrito Industrial
São Paulo - SP - Brasil CEP 12412 800
Telefone: +55 (12) 2126 2700
www.circuit.com.br - sac@circuit.com.br

CIRCUIT EQUIPMENT ITALIA SRL

Via Roggia Colleonesca 10/12
24127 Bergamo [BG] - ITALIA
Tel: +39 035 506161
www.circuitequipment.it - info@circuitequipment.com

CIRCUIT EQUIPMENT U.S.A.

8600 Commodity Cir #139
Orlando, FL - 32819 USA
phone: +1(520) 928 4877
www.circuitequipment.us - lia@ibgtrade.me

IBG TRADE - CIRCUIT EQUIPMENT UAE

Dubai World Center
P. O. Box: 390667
39067 Dubai - UAE
T: +97150 3761641
www.circuitequipment.me - chrissy@ibgtrade.me

 @circuitequipment_

 Circuit Equipment

 Circuit Equipment Official



WWW.CIRCUIT84.COM

2024